

SOJAG

produits saisonniers • seasonal products

Sojag code : 999-8162950

CUP/UPC code : 772830162950

QUESTIONS? 1 866-901-1649

Assembly Manual / Guide d'assemblage / Manual de ensamblaje / 조립설명서 / Montageanleitung

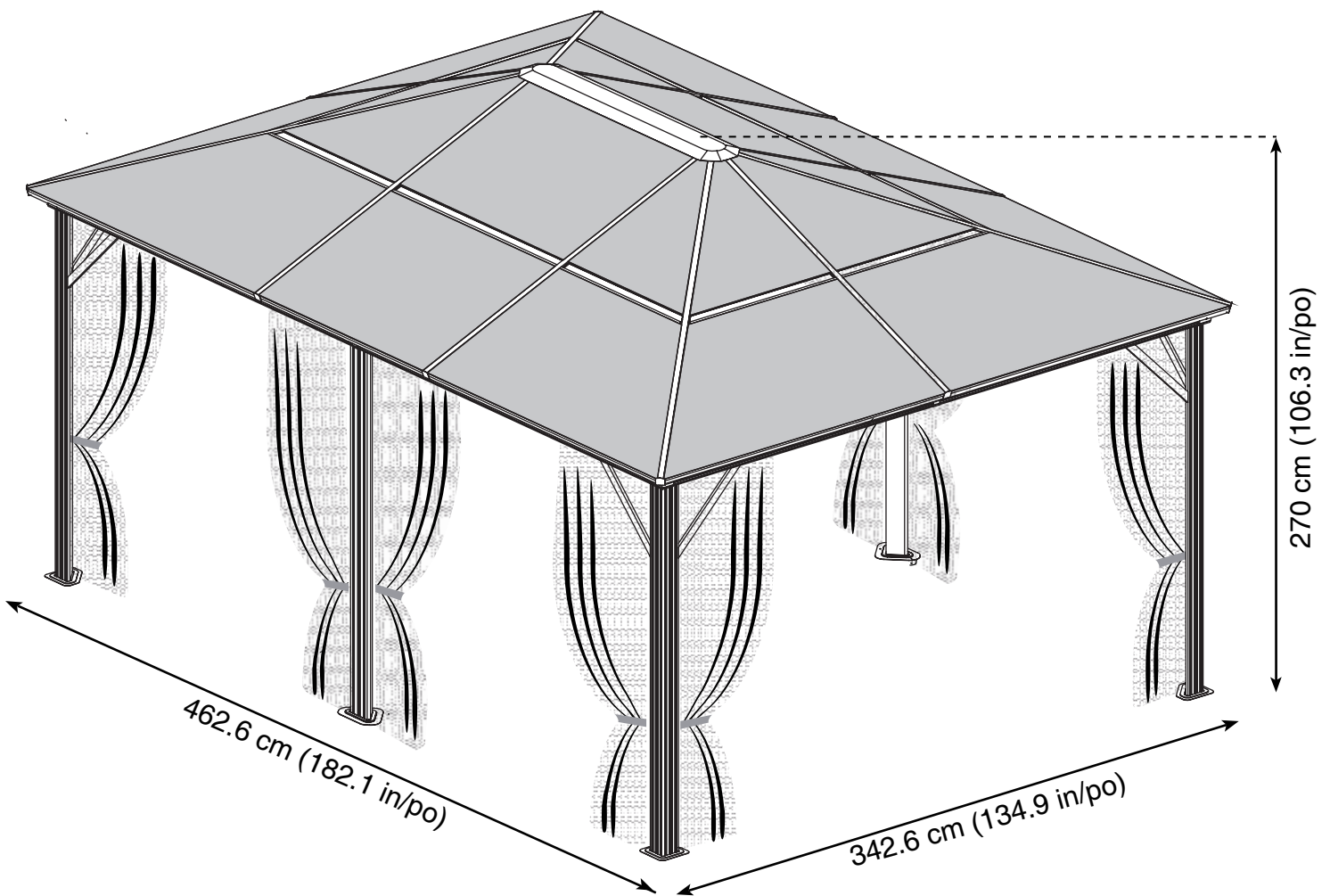

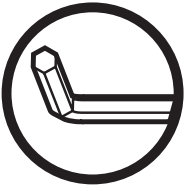

Use the hex keys in the box. / Utilisez les clés hexagonales fournies dans la boîte. /
Utilice las llaves hexagonales en la caja. / 상자에 육각 키를 사용 하십시오. / Verwenden Sie
die Sechskantschlüssel in der Box.

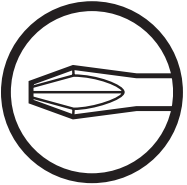

Please use a Phillips screwdriver. / Utilisez un tournevis de type Phillips / Por favor,
use un destornillador Phillips. / 십자 드라이버를 사용 하십시오. / Bitte verwenden
Sie einen Kreuzschraubenzieher.



You may need to use a drill for this step. / Vous pouvez avoir besoin d'utiliser une
perceuse pour cette étape. / Puede que tenga que utilizar un taladro para este paso. /
이 단계에선 드릴을 사용해야 할 수도 있습니다. / Für diesen Schritt können Sie einen
Bohrer verwenden.



Wearing protective gloves is recommended. / Le port de gants de protection est recommandé /
El uso de guantes de protección se recomienda. / 보호 장갑을 착용 하는 것이 좋습니다. /
Das Tragen von Schutzhandschuhen wird empfohlen.



Two or more people are required at this stage. / Deux personnes ou plus sont nécessaires à cette
étape. / Dos o más personas se requieren en esta etapa. / 이 단계에서는 두 명 이상 이 필요합니다. /
Für diesen Bauschritt sind 2 oder mehr Personen erforderlich.



Do not tighten screws all the way for now. / Ne pas visser fermement pour l'instant. /
No atornille con firmeza por ahora. / 아직 나사를 단단히 조이지 마십시오. / Bitte die
Schrauben zum jetzigen Zeitpunkt noch nicht fest anziehen.



Sold separately. / Vendus séparément. / vendido en las opciones. /
옵션 판매 / Optional erhältlich

U X68(+6)

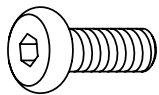

U1 X 52 (+5)

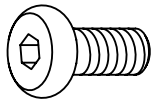

U2 X2 (+1)



V X 16 (+3)

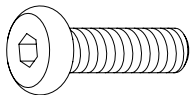

V1 X1 (+1)

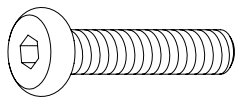

W X 16 (+2)

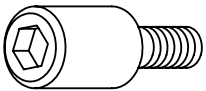

X X 10 (+2)

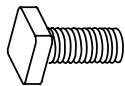

X1 X 30 (+6)



Y X 24 (+4)

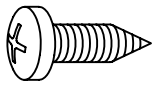

Y1 X 20 (+4)

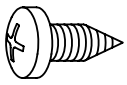

Z X1

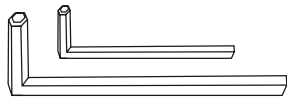

Z1 X2

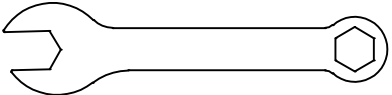



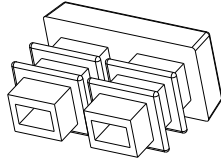





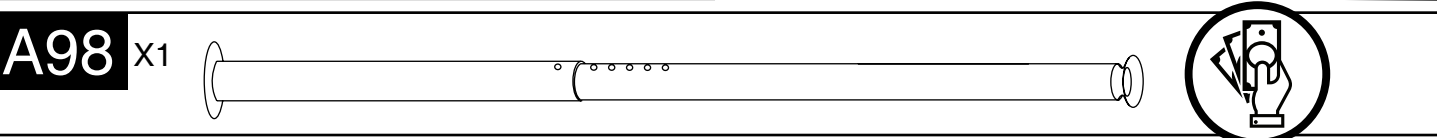
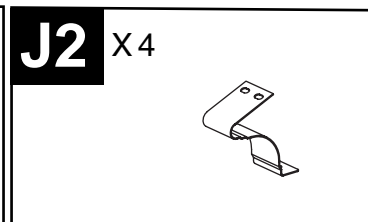
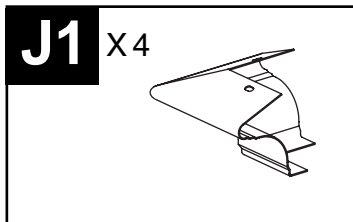
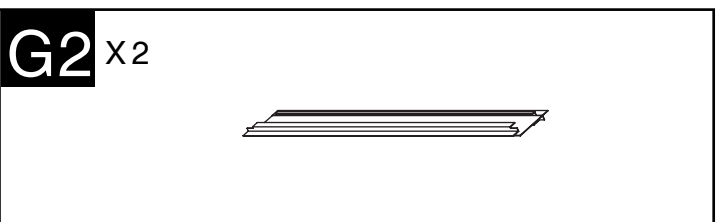
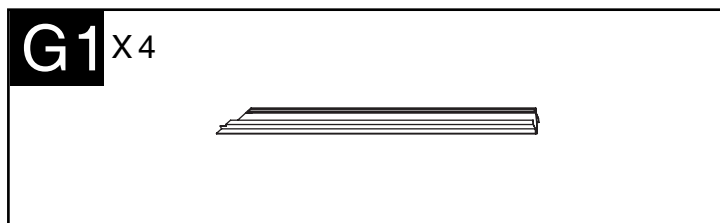
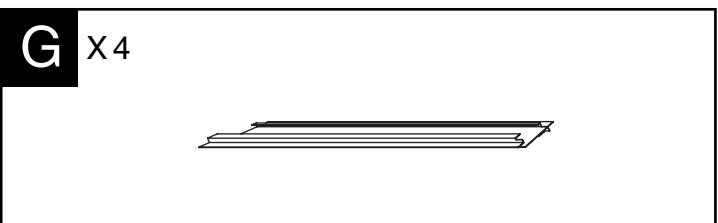
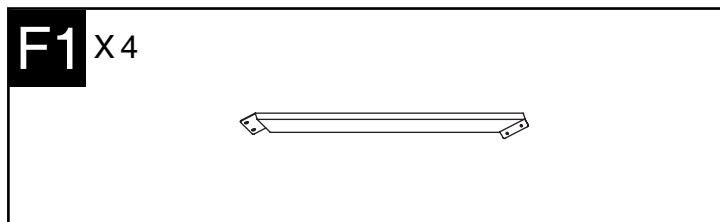
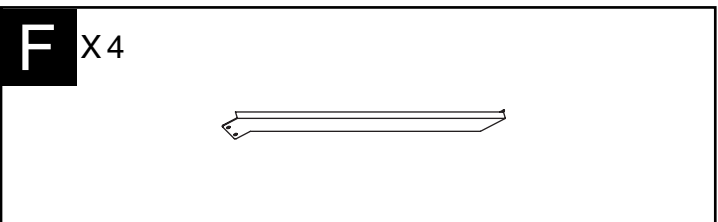
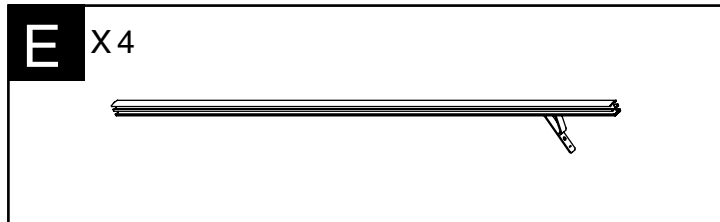
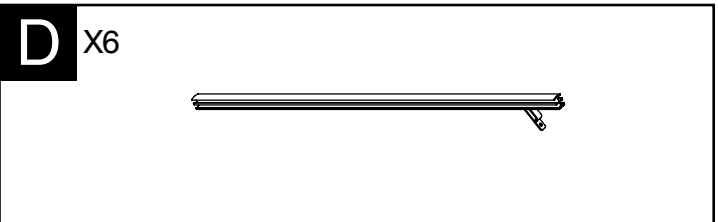
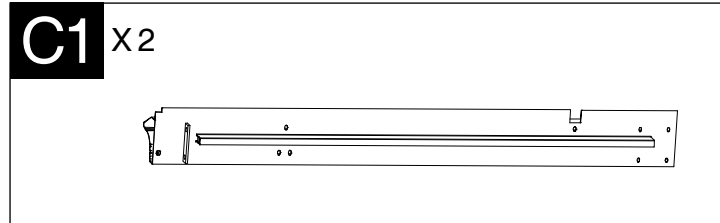
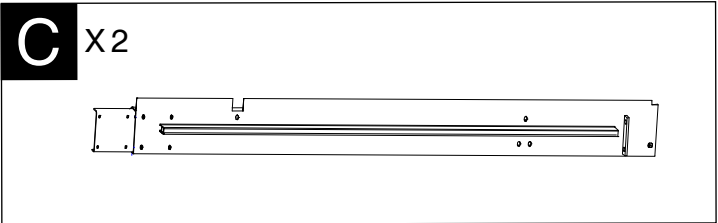
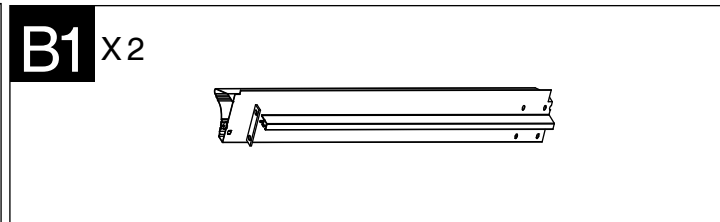
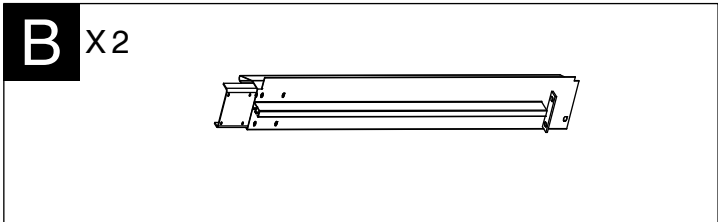
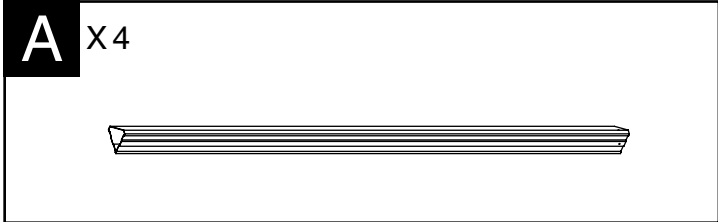

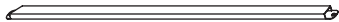

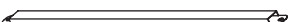
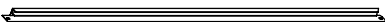

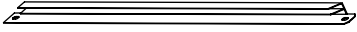
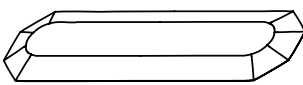
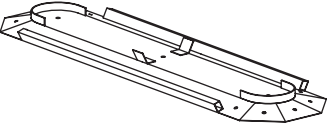
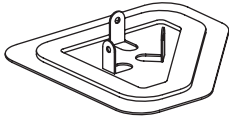
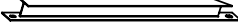
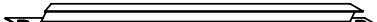
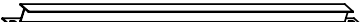

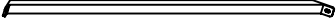
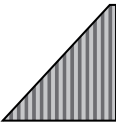
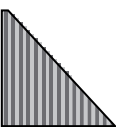
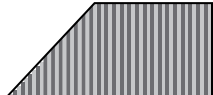
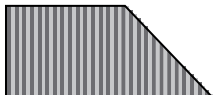
Z2 X4(+1)

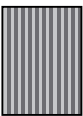

Z3 X8(+2)

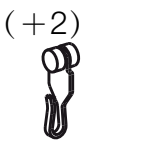
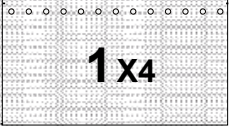
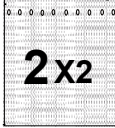

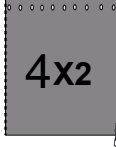

H X4 	H1 X4 	H2 X2 
I X4 	I1 X4 	I2 X2 
K X1 	K1 X1 	L X6 
N X4 	N1 X4 	
N2 X2 	O X4 	O1 X6 
Q X4 	Ma X4 	M1a X4 
Mb X4 	M1b X4 	
P X2 	P1 X2 	T X 68 (+2) Optional  
		T X 68 (+2) Optional  
Net  1x4  2x2  Optional	Curtain  3x4  4x2  Optional	

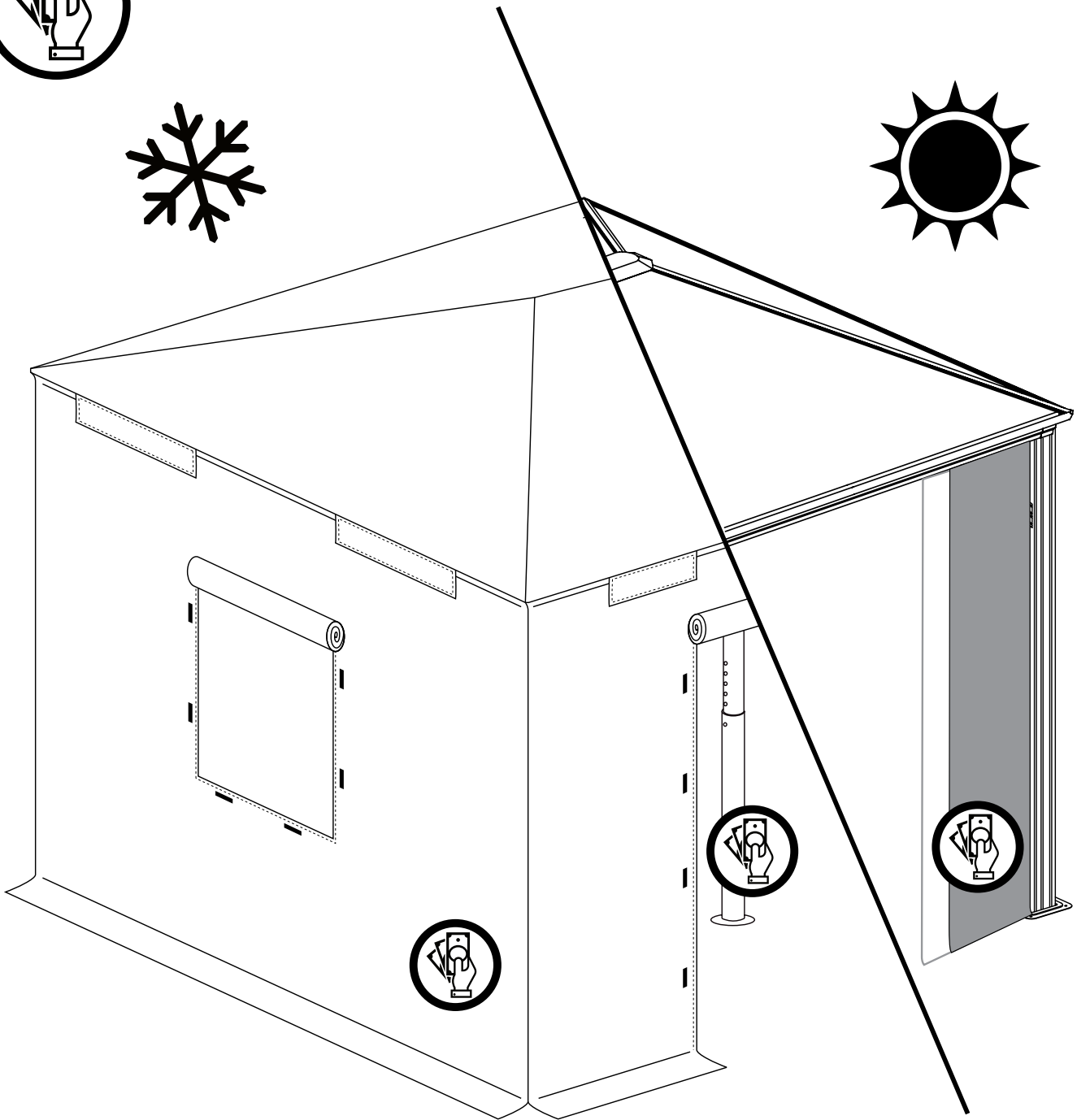
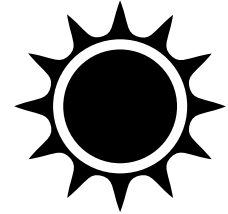
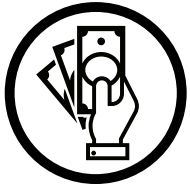

A98 x1



Rx1

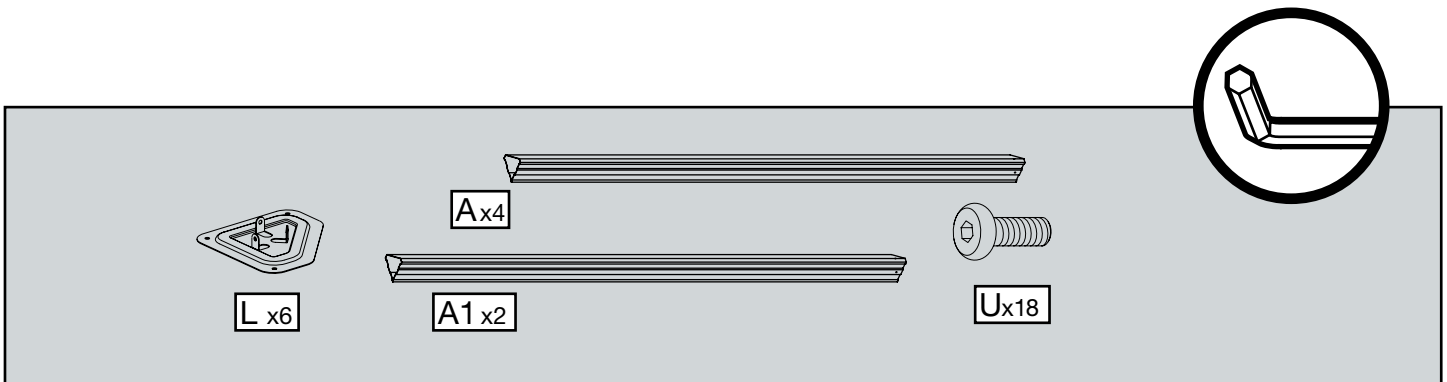
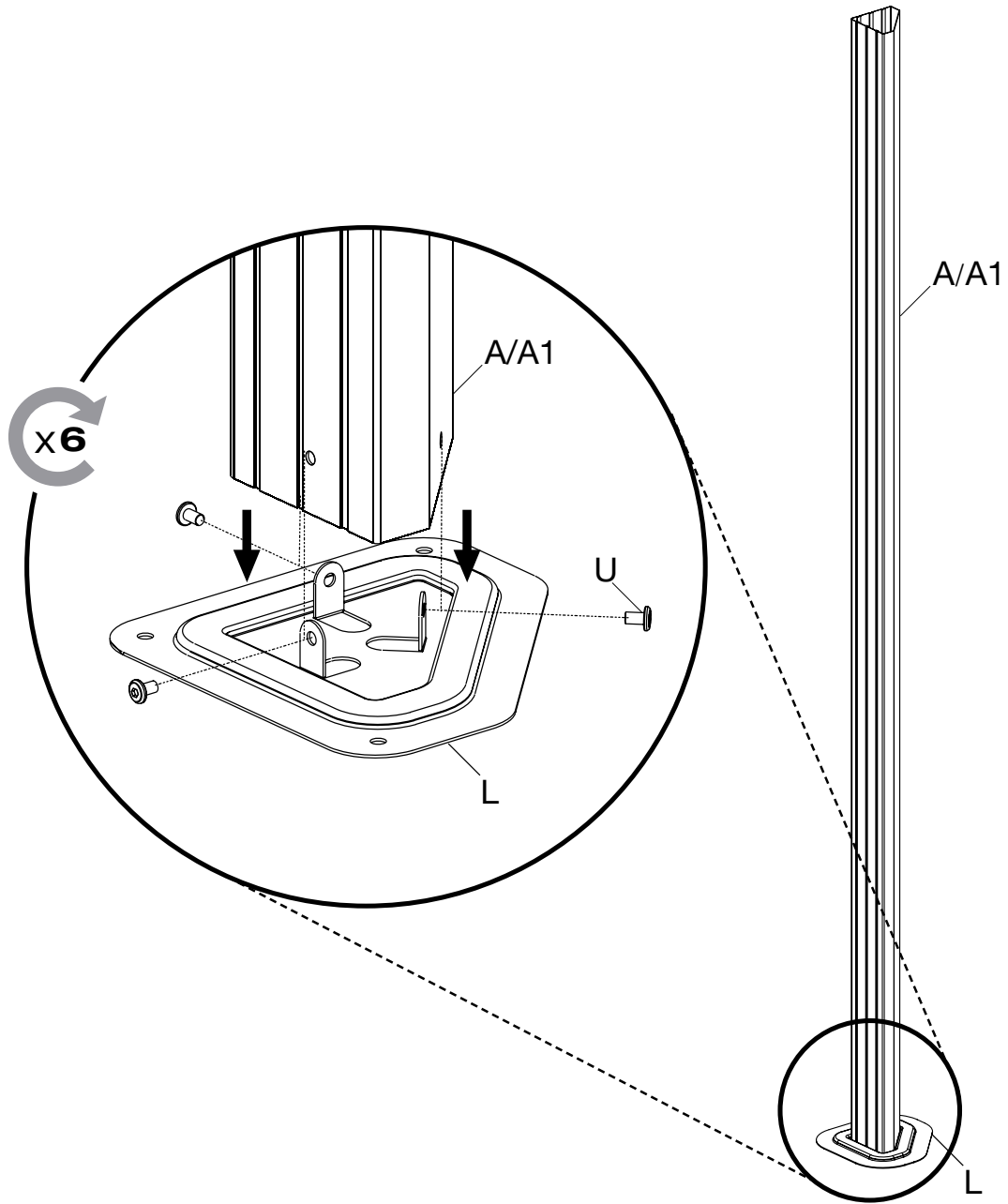

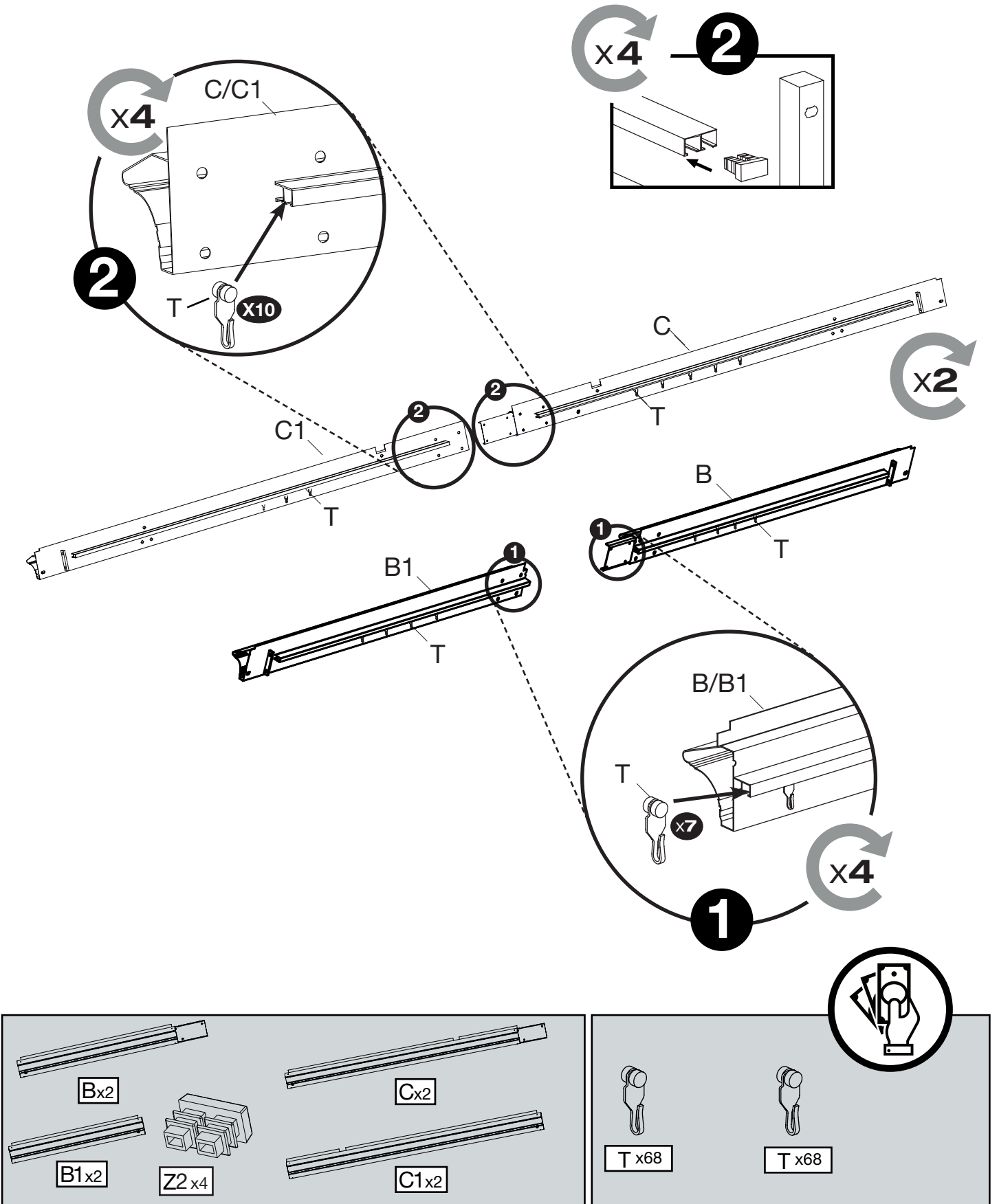

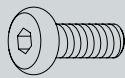
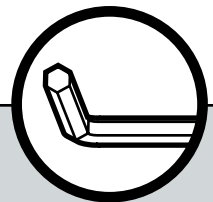
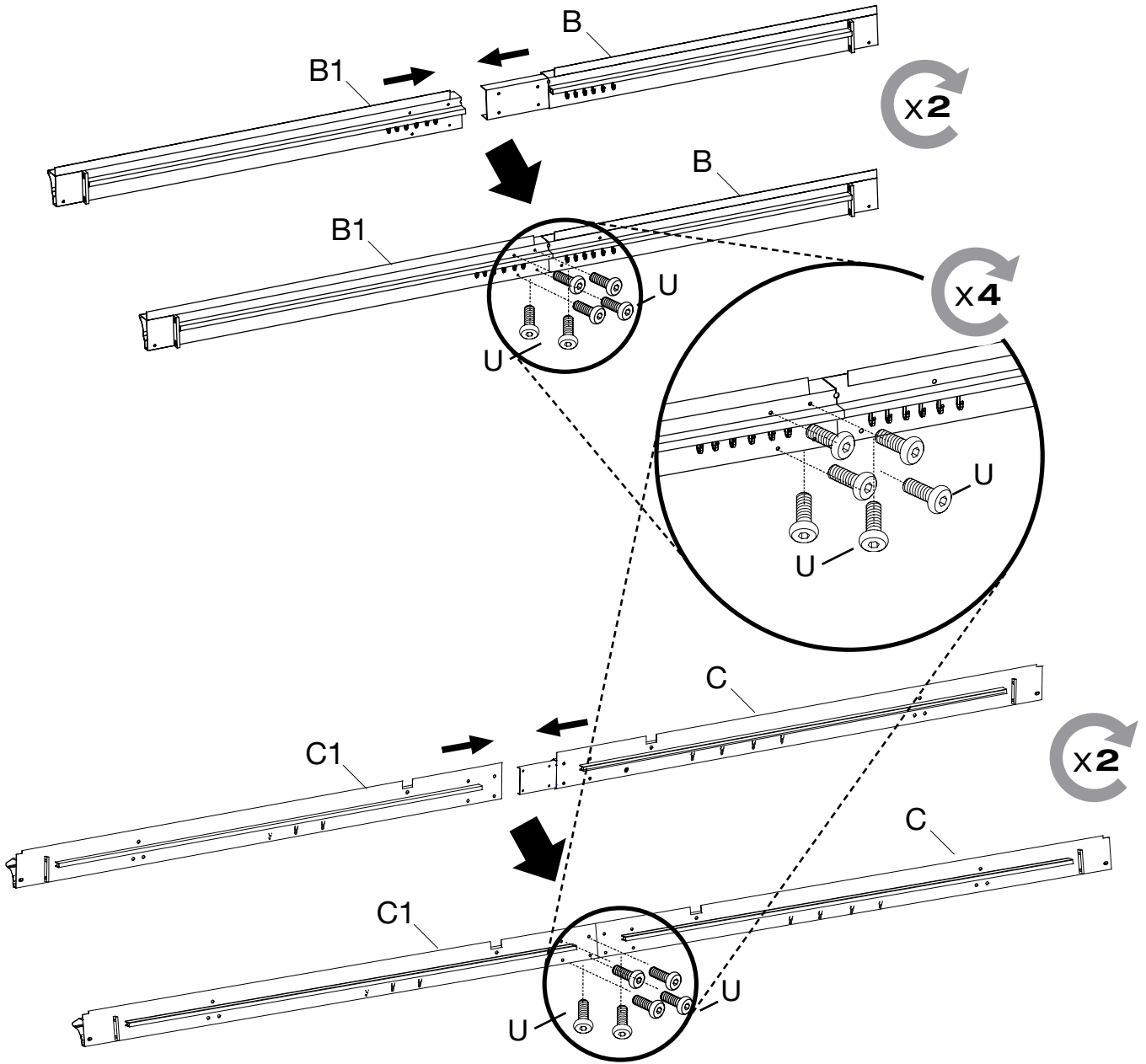

Ux24

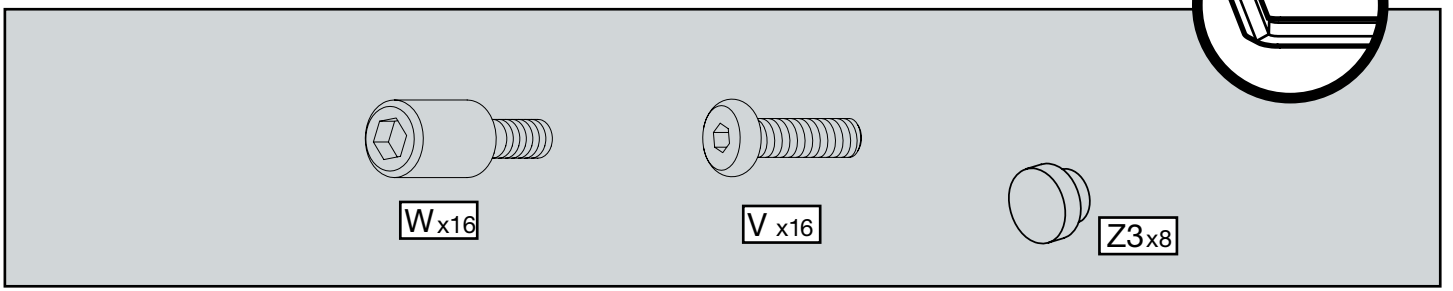
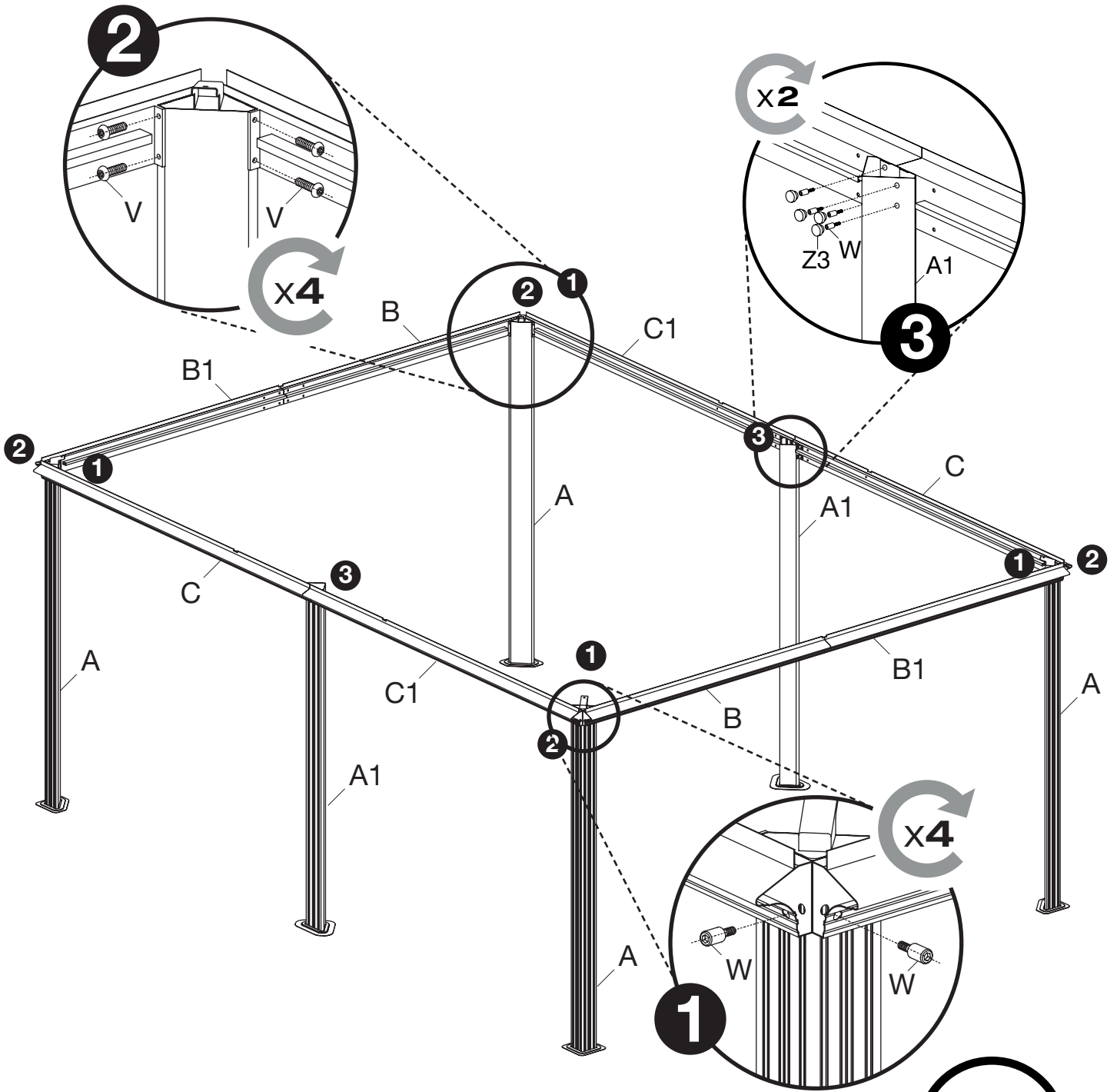

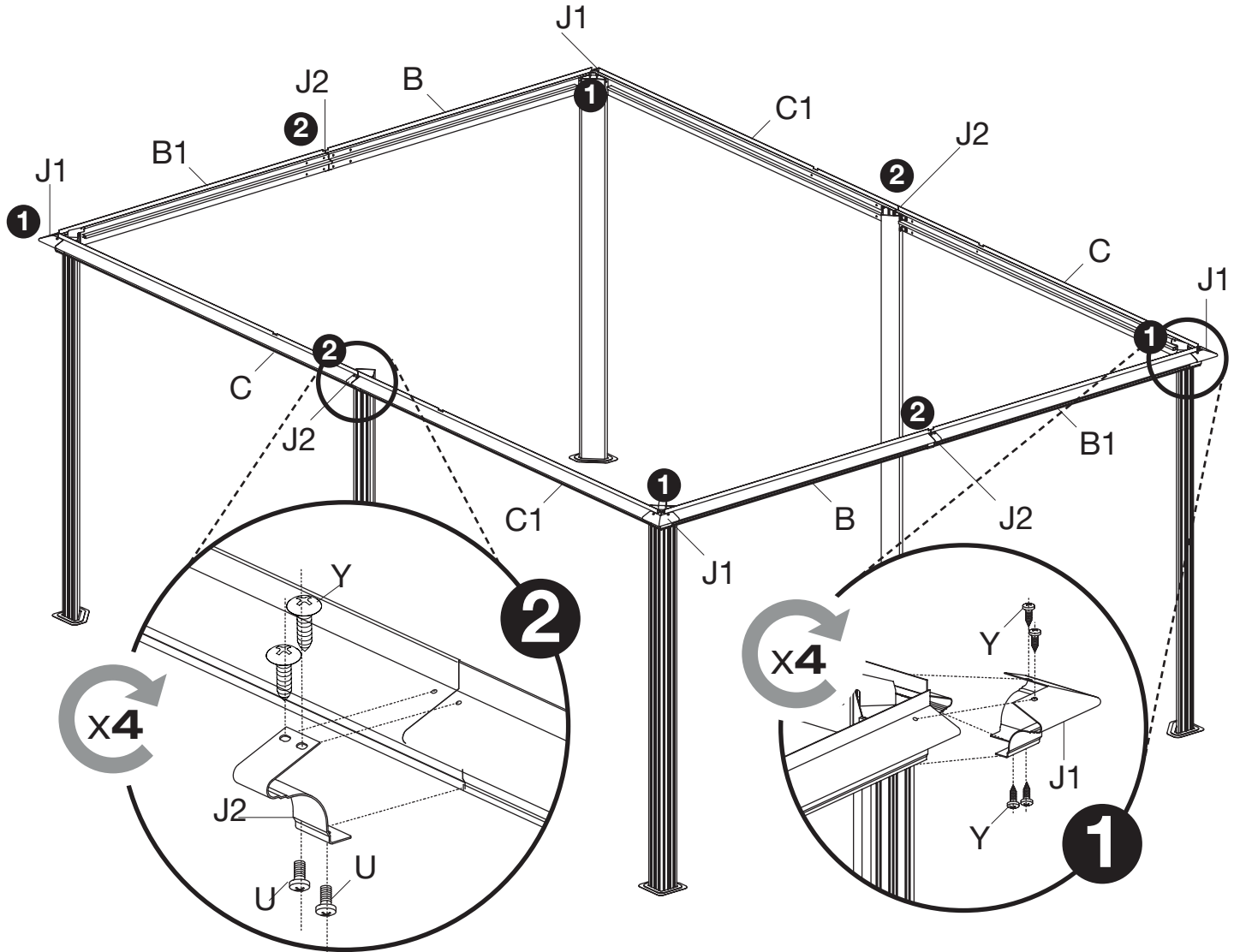

This section contains a parts list and tool icons. The parts list includes:

- Screw Y x24
- Screw U x8
- Bracket J1 x4
- Bracket J2 x4

Two circular icons show the tools required for assembly: a Phillips screwdriver and an Allen key.

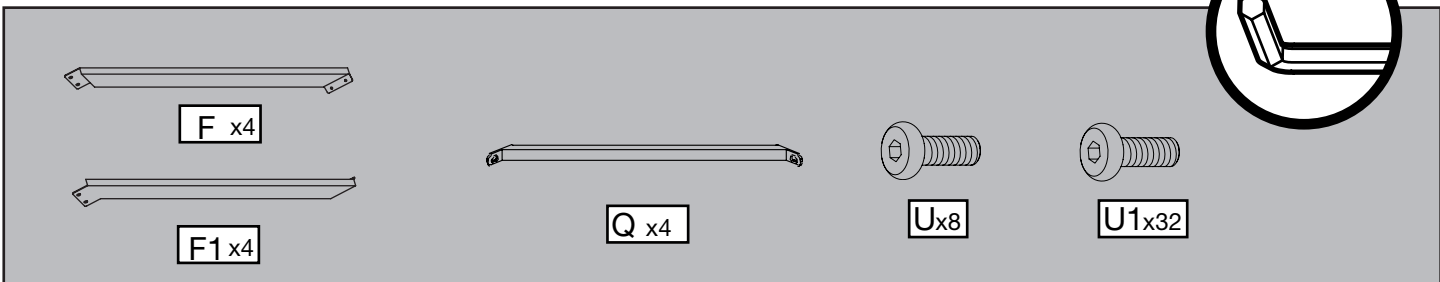
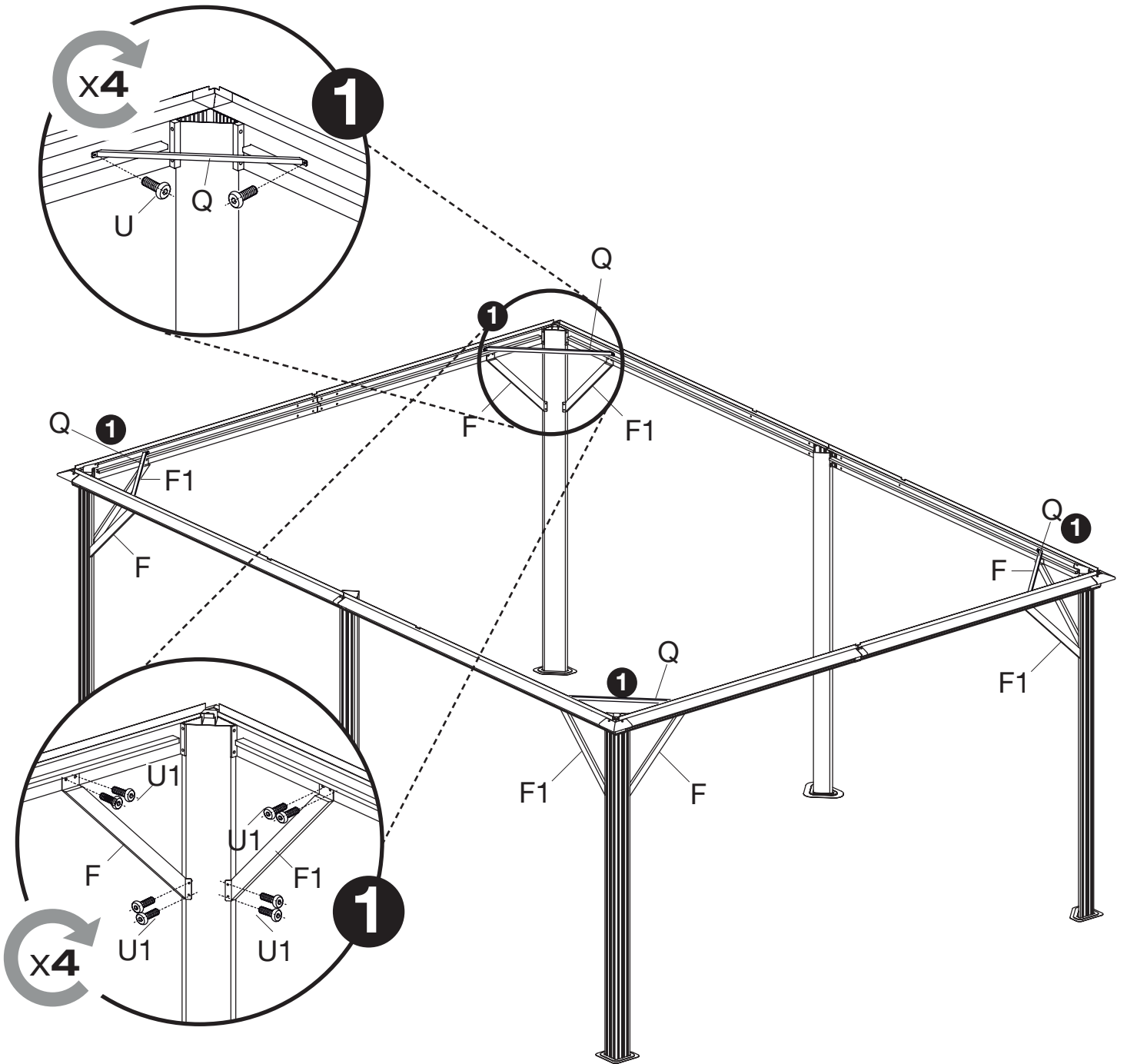

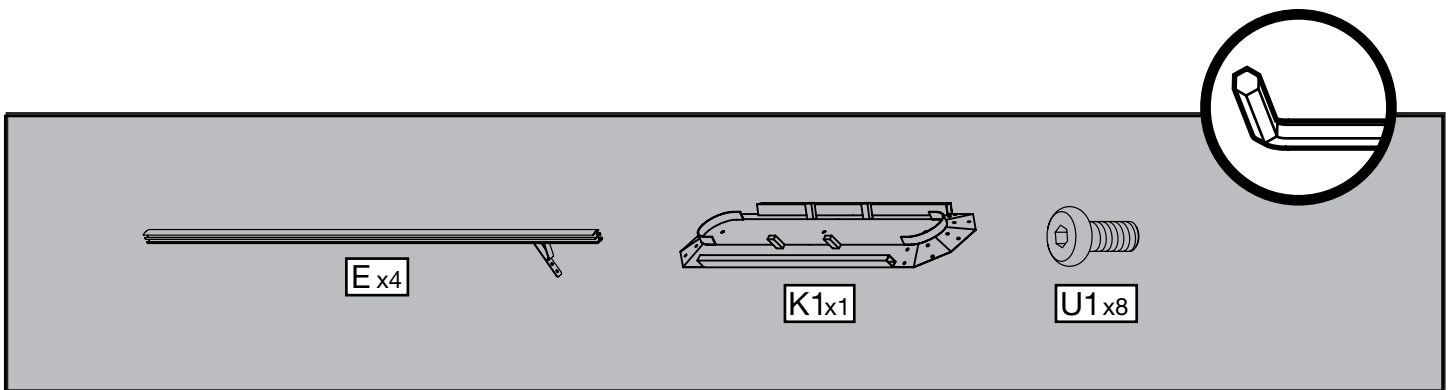
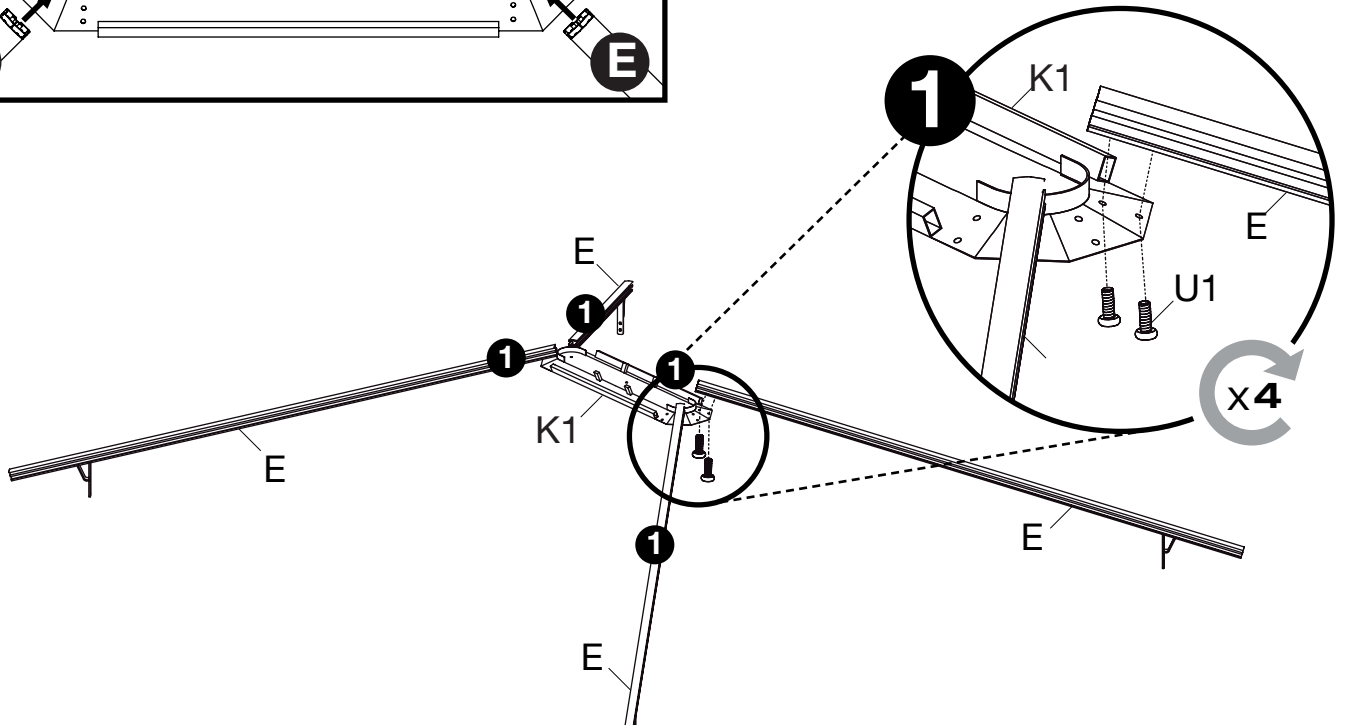
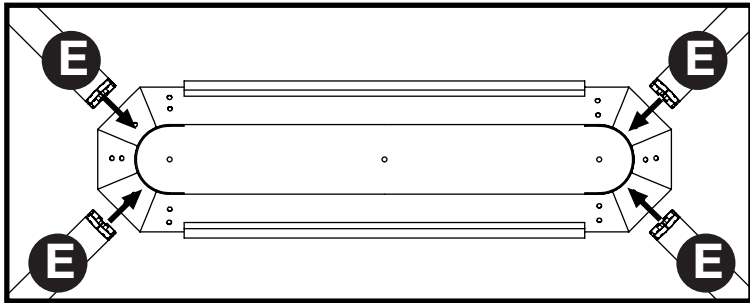

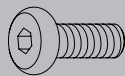
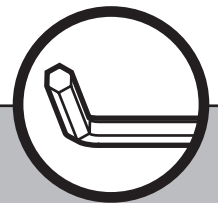
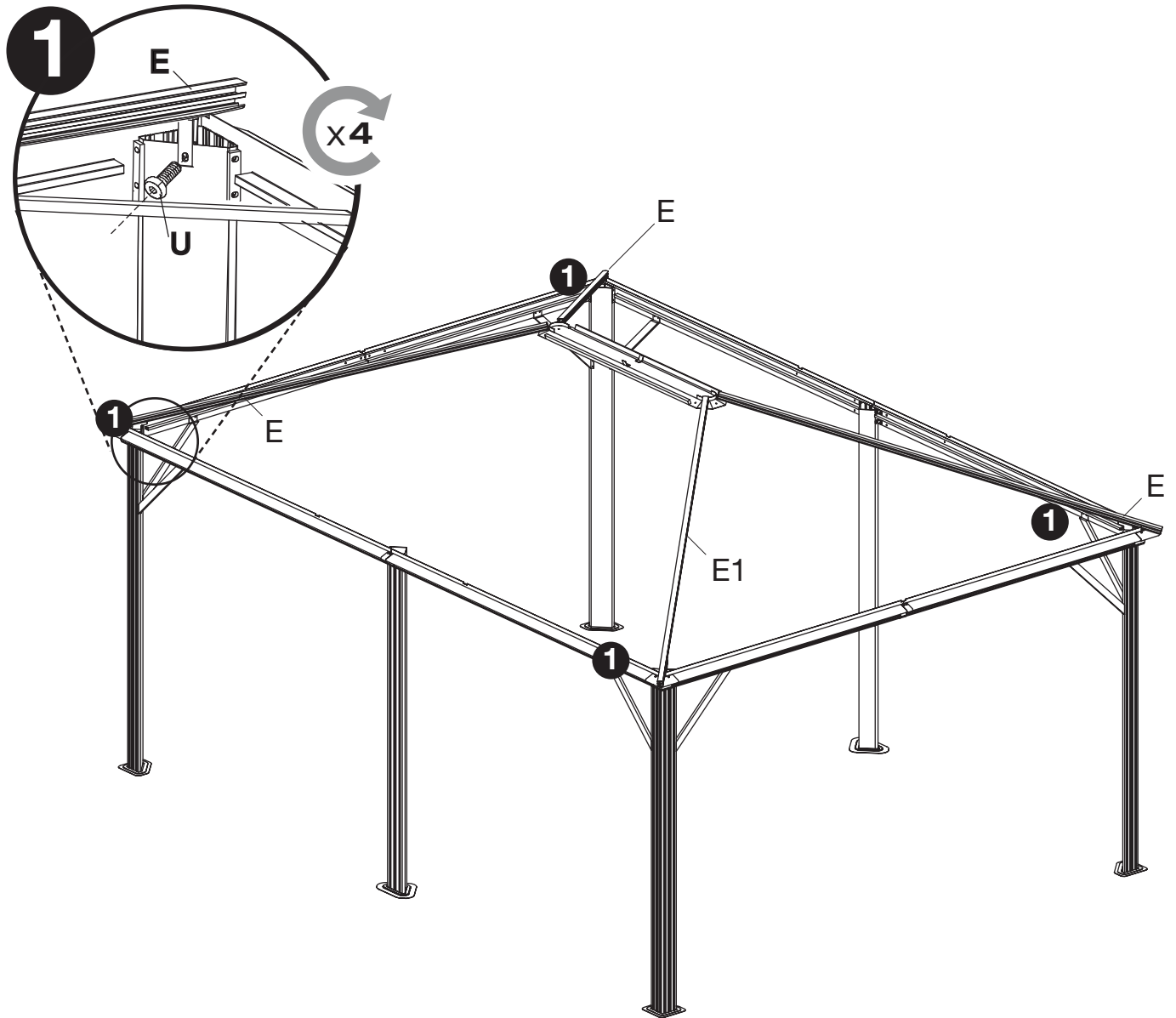

Ux4

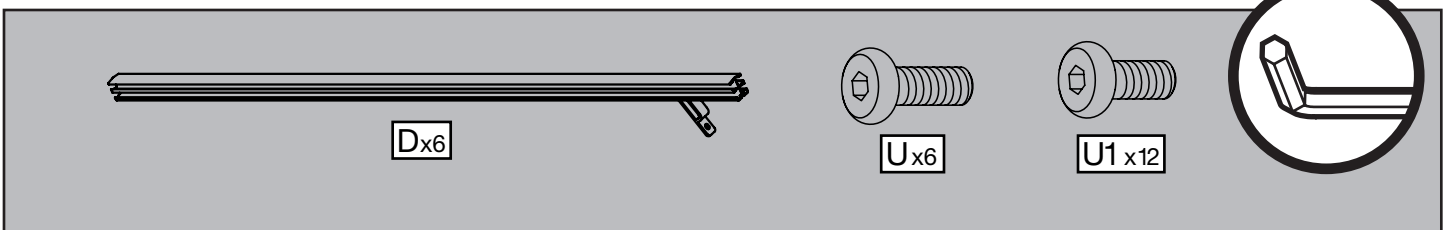
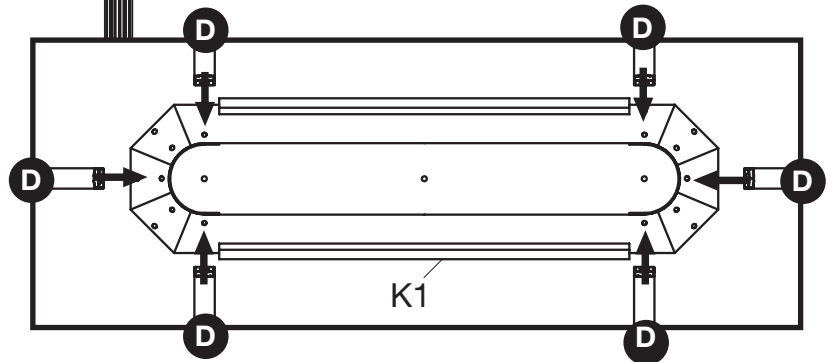
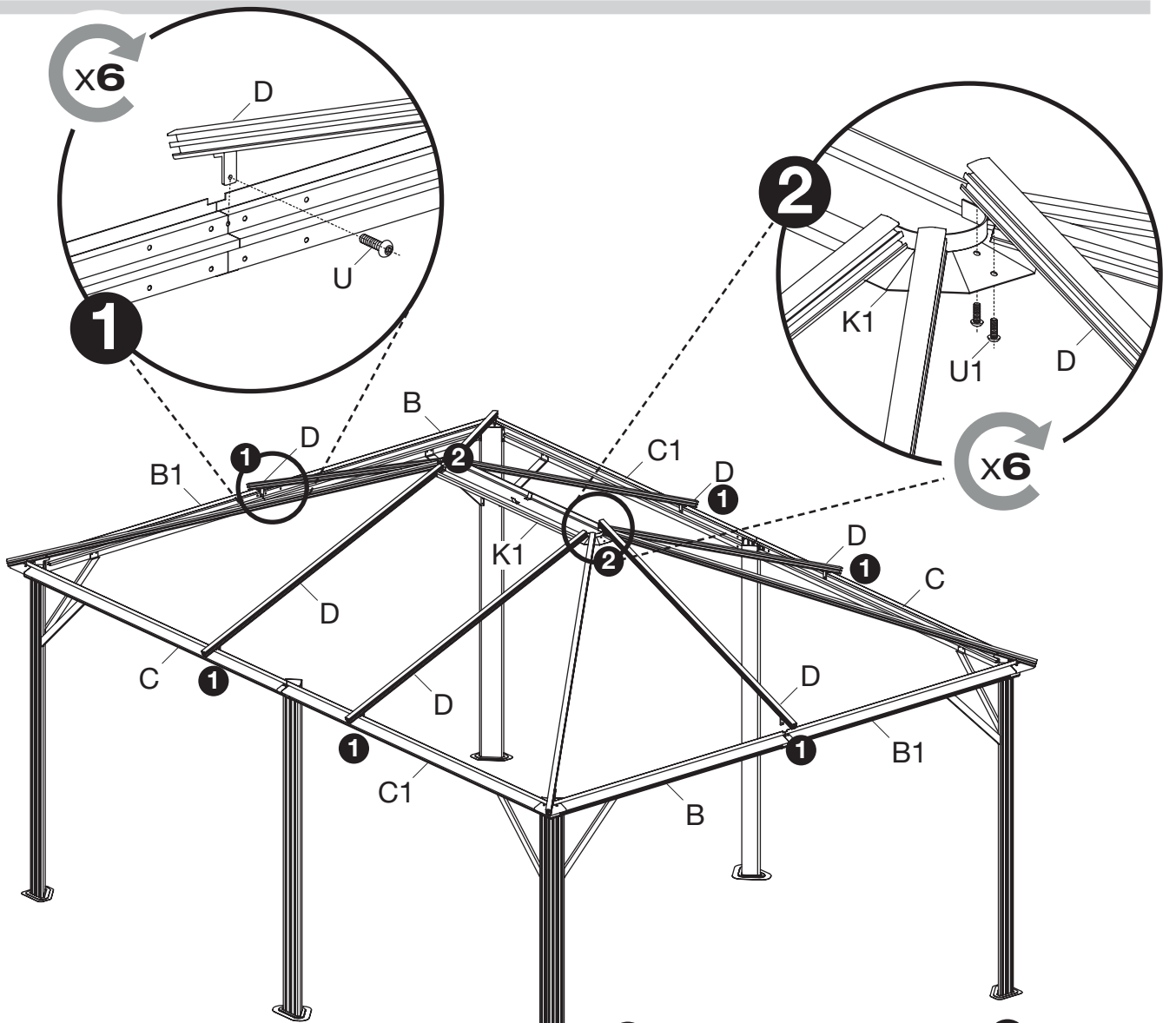

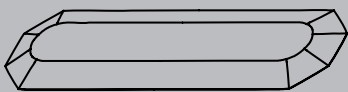
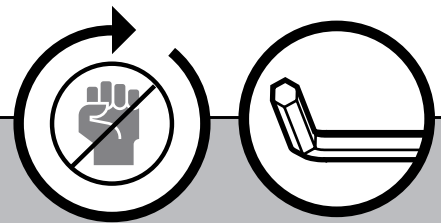
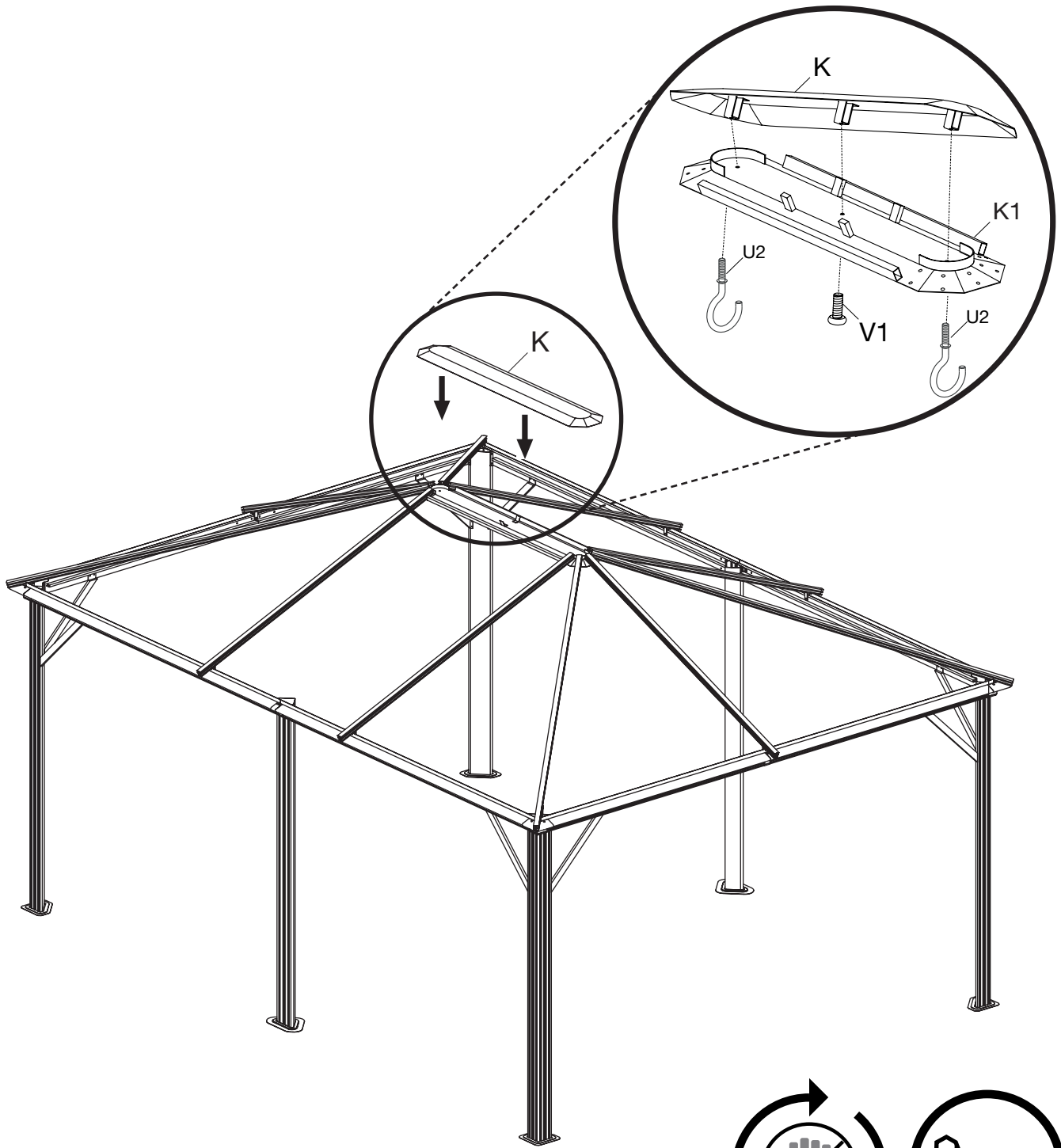

Kx1

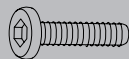

V1 x1



U2 x2

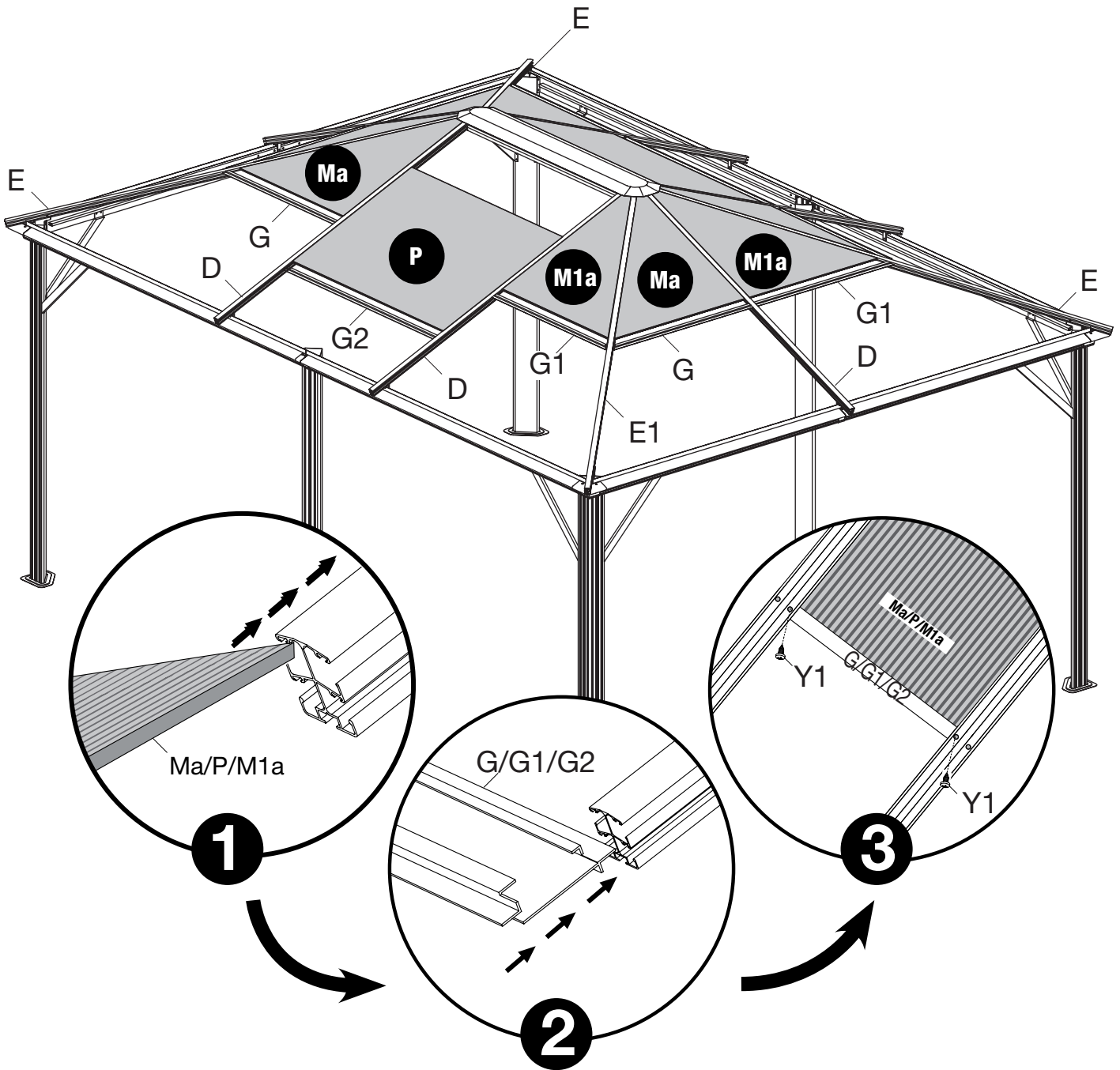

A parts list and safety icon are located at the bottom of the page. The parts list includes:

- Ma x4 (four triangular panels)
- P x2 (two rectangular panels)
- M1a x4 (four trapezoidal panels)
- Y1 x20 (twenty screws)
- G x4 (four long beams)
- G1 x4 (four medium beams)
- G2 x2 (two short beams)

A safety icon of a pair of hands is also present.

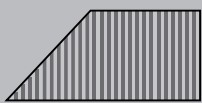
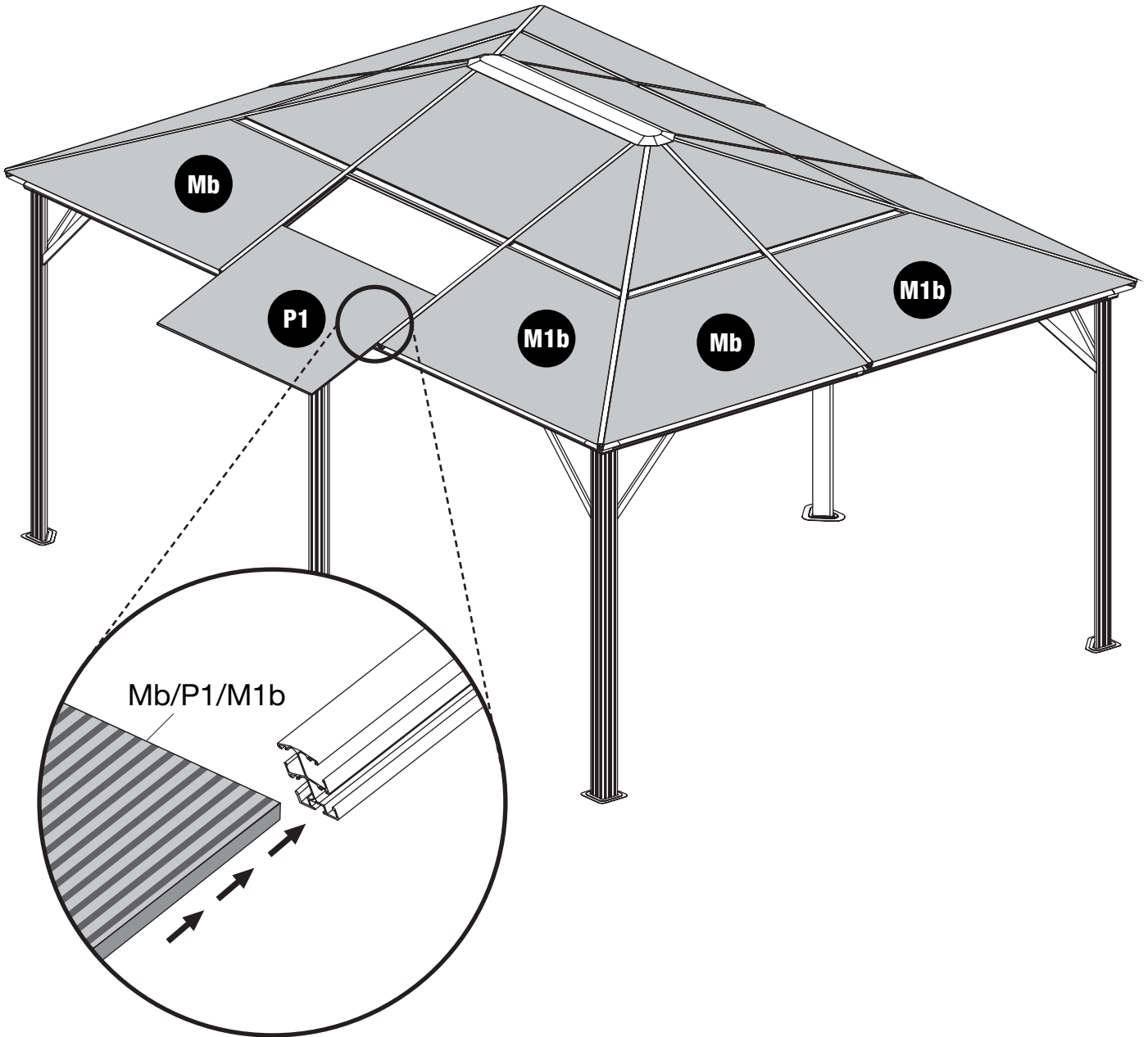

Mb_{x4}





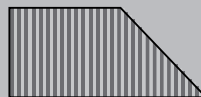

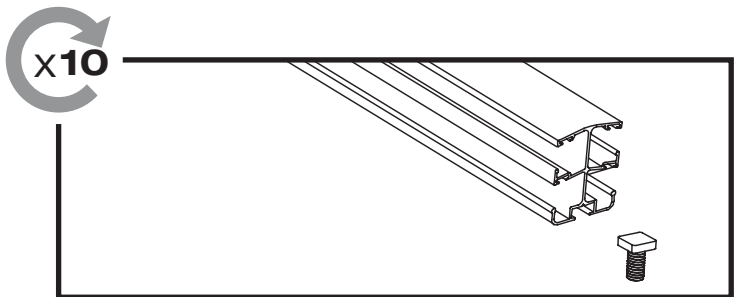
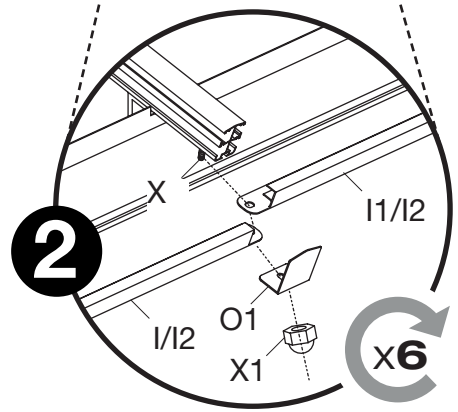
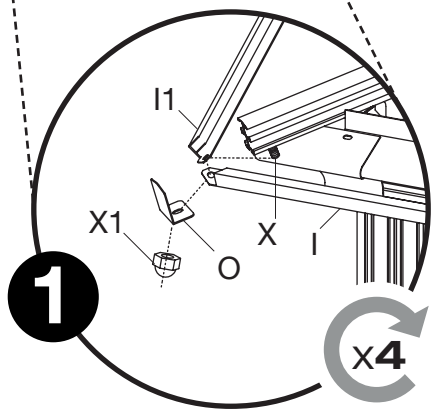
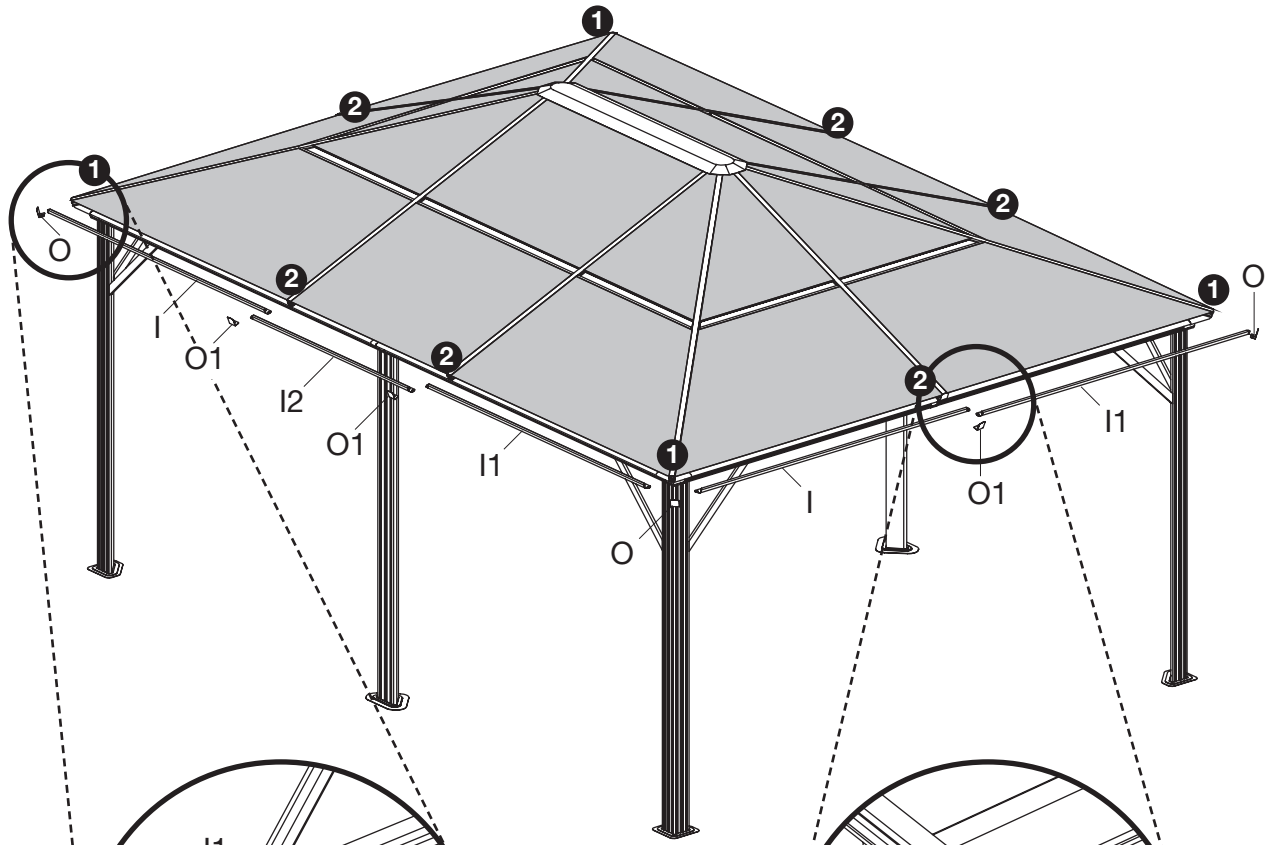

P1_{x2}



M1b_{x4}



 I x4	 I2 x2	 O x4	 O1 x6	 X x10	 X1 x10
 I1 x4					

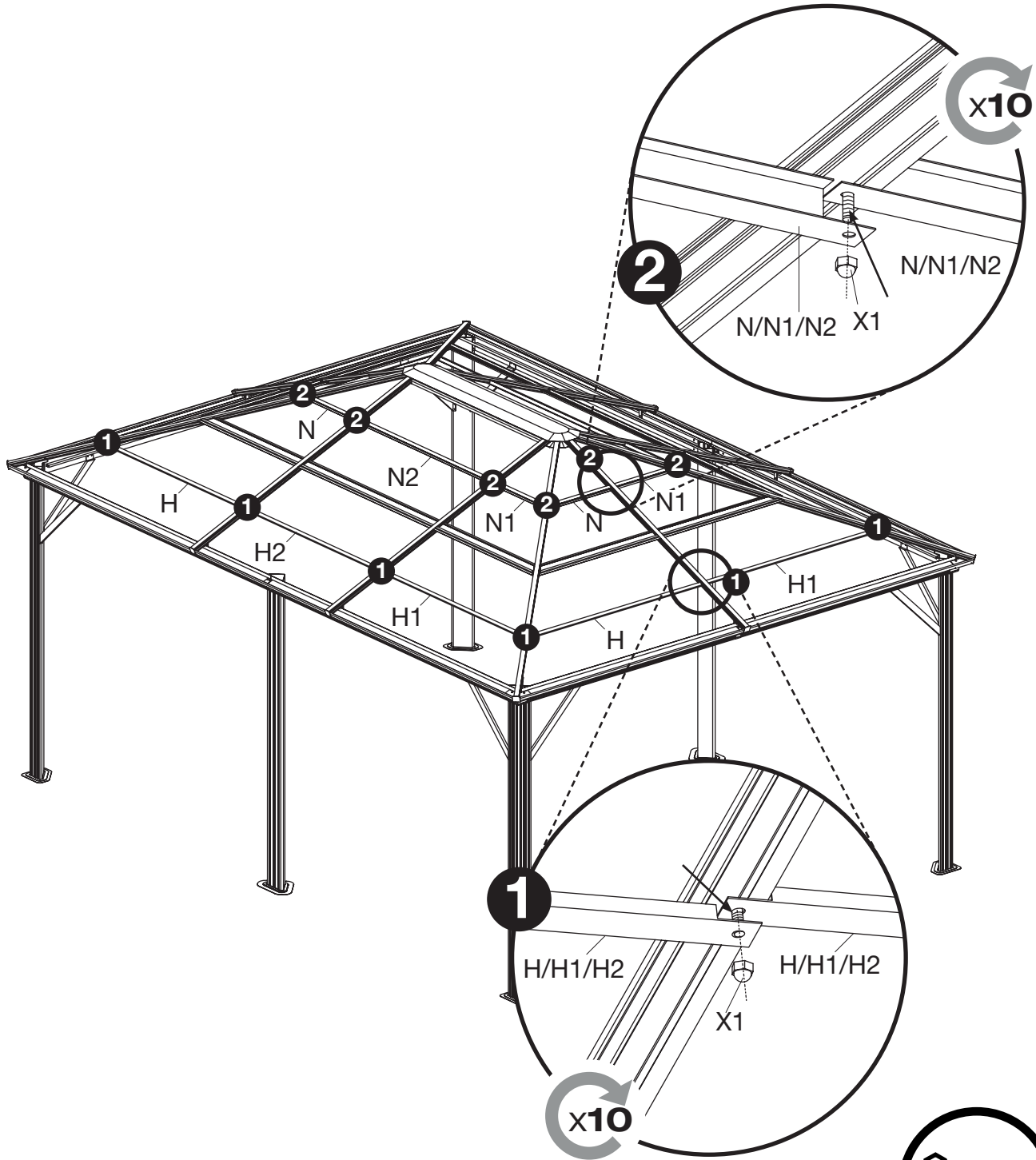

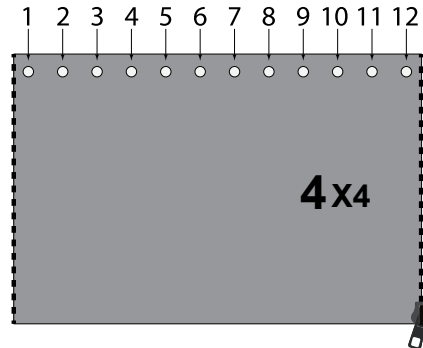
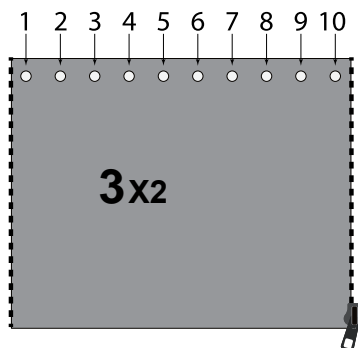
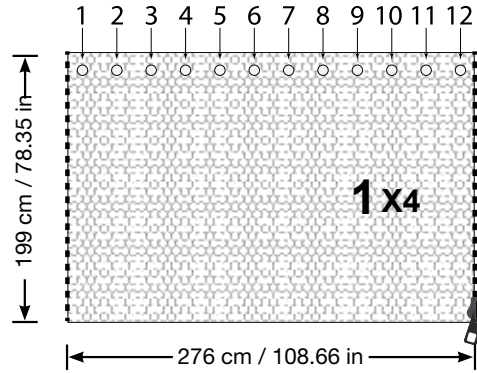
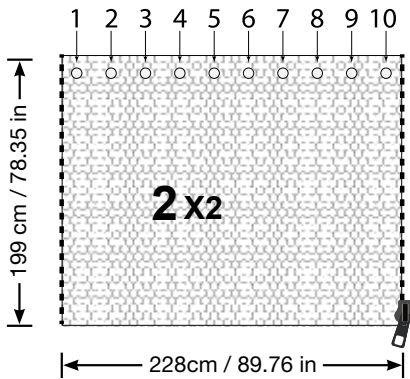
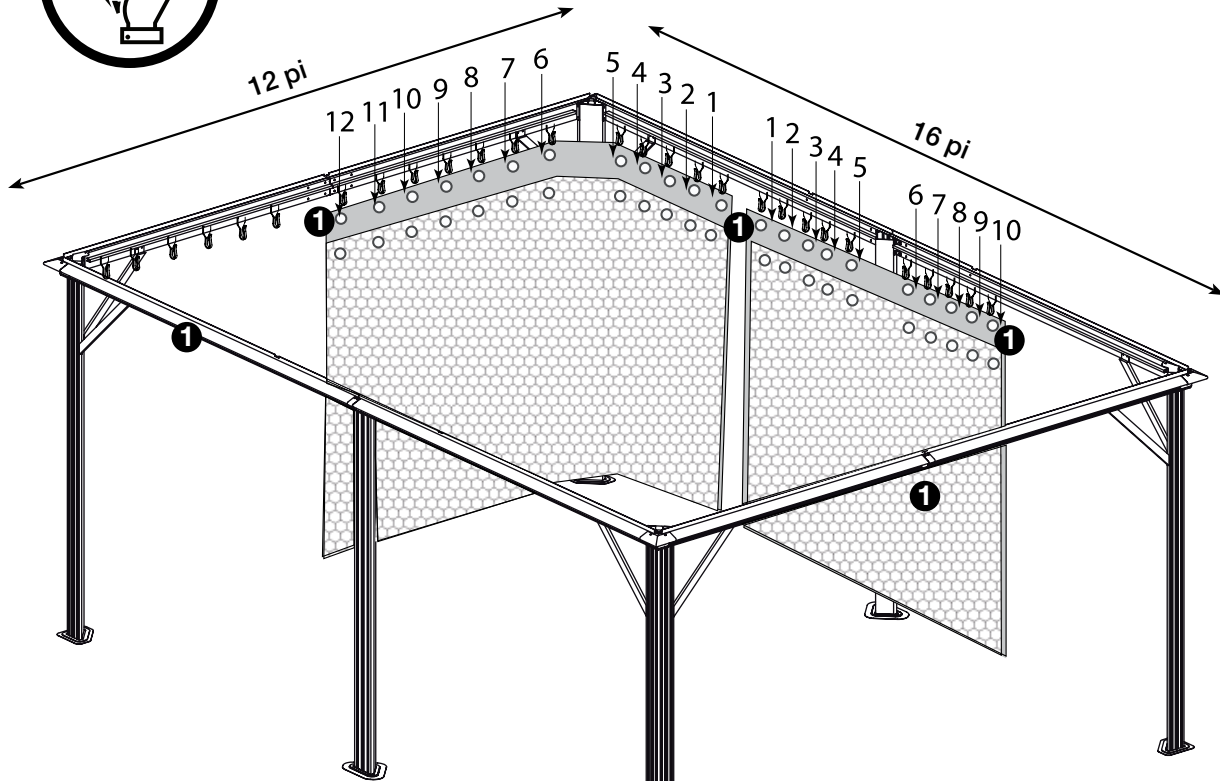
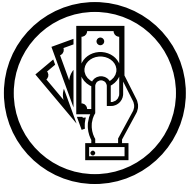

SOJAG ■ I
produits saisonniers • seasonal products