

THERMORY®

WELCOME
TO A WORLD
OF WELLNESS,
RELAXATION,
AND BEAUTY

Standard elements
and building materials
for custom saunas

STS4 thermo-aspen, private house in Estonia
Photo by Elvo Jakobson

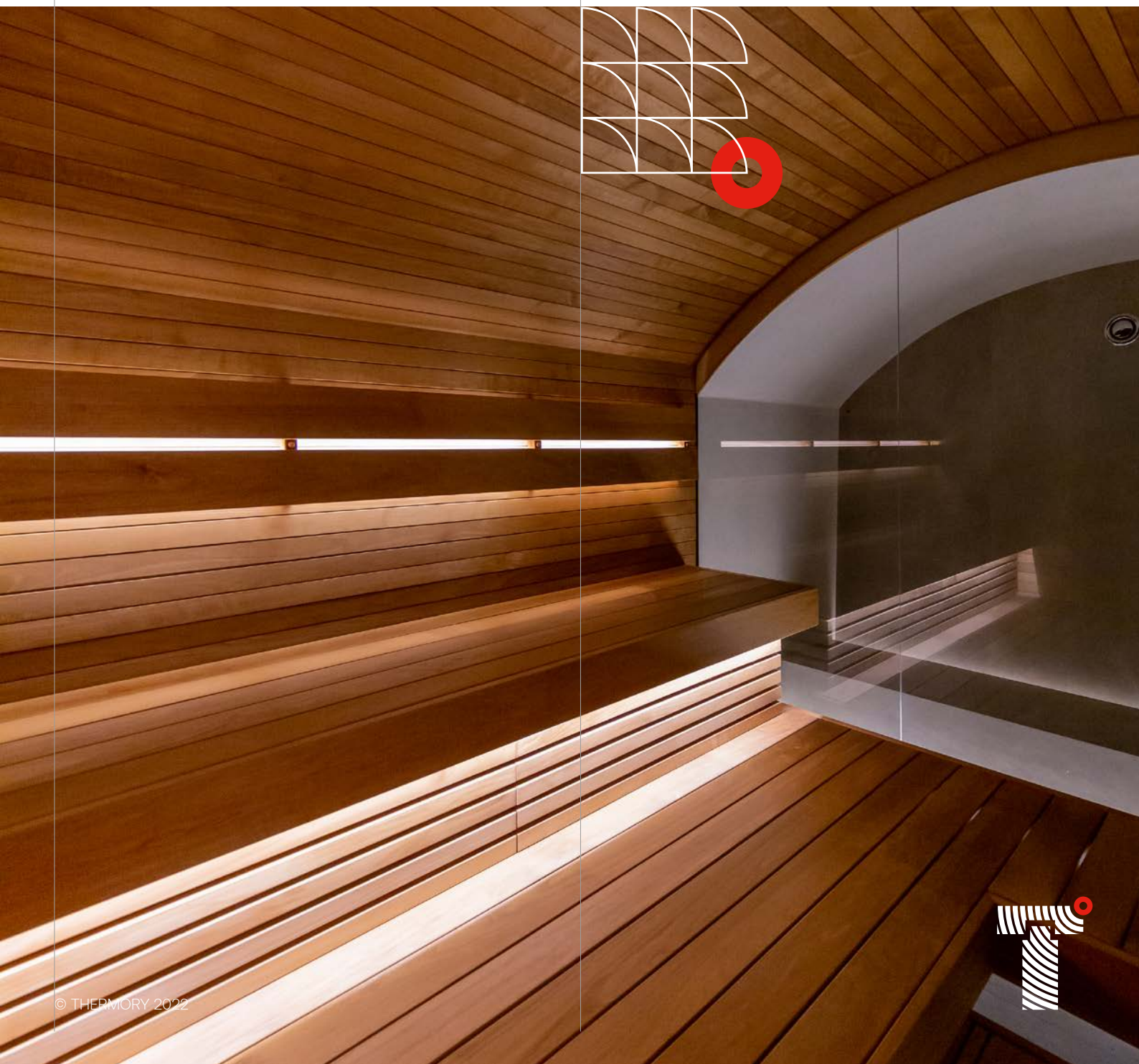

Thermory has been producing quality wood products for over 25 years, and we offer a complete range of high-quality materials, ready-made elements, and accessories for sauna design. Whether you're looking for a complete sauna that's ready to install or individualized components to custombuild your own dream design, we'll help you create a sauna space that looks great and leaves you feeling energized and refreshed.

Our broad range of wood species, profiles, and dimensions caters for a variety of styles, offering everything from standard sauna materials to distinctive products with novel designs that allow those with a bolder outlook to create a wellness space that combines convenience and practicality with striking visual features.

With a choice of natural, thermally modified, brushed, and painted wood finishes, our unrivaled range of options will ensure that you can design a sauna experience that's just right for you. And if you're looking for a quick and easy solution, we also offer a wide range of ready-made elements, from wall panels and bench boards to doors and accessories.



Walls and ceiling: Vire 15x69 thermo-aspen, bench: SHP 15x90 thermo-aspen. Private house, Estonia. Photo by Elvo Jakobson

1. We are Thermory®	3	6.3 Bench skirts	21
2. Thermal modification	4	6.4 Movable benches	22
3. Wood treatments and finishes	5	6.5 Heater guards	23
4. Wood types for the sauna	6	6.6 Arm rests	24
5. Sauna materials	8	6.7 Floor grids	24
5.1 Wall panels	8	7. Sauna accessories	25
5.2 Mouldings	13	7.1 Lightning covers	25
5.3 Bench boards	15	7.2 Ventilation hatches	25
5.4 Bench frontboards	16	7.3 Ventilation grids	26
6. Ready-made sauna elements	17	7.4 Head rests	26
6.1 Bench modules	17	7.5 Seat rests	26
6.2 Backrests	20	8. Sauna doors	27



1. We are Thermory®

Thermory is the world's largest manufacturer of chemical-free thermally modified timber and sauna materials. Over 90% of our sales are exported to more than 50 countries.

We're dedicated to offering real wood solutions that exceed expectations and enhance environments, and our product portfolio includes decking, cladding, and floorboards made from thermally modified timber and coated wood products for interior and exterior use.

We are also a major player in the sauna, spa, and wellness sector; as the world's leading manufacturer of sauna materials and ready-made saunas, Thermory saunas can be found in homes and public spaces worldwide.



100% REAL WOOD PRODUCTS



QUALITY MATERIALS

An unbeatable range of wood species, profiles and finishes



INDUSTRY EXPERTS

Delivering superior quality and unrivaled beauty for over 20 years



SUSTAINABLE

Wood from sustainably managed forests with chemical-free modification



2. Thermal modification

Thermally modified timber is our key strength at Thermory. With our exclusive, state-of-the-art technology and years of expertise, we know exactly how to bring out the best in wood.

Thermally modified wood is natural – its properties are enhanced using just heat and steam. This chemical-free process results in an environmentally friendly and aesthetically pleasing material that’s significantly more durable and stable than conventional timber.

As well as offering these practical benefits, our thermal modification treatment also creates dynamic visual effects, with the wood taking on an appealing darker brown shade. The intensity of the color depends on the wood type and the duration and temperature of the modification process. The highest temperature of medium thermal modification is 190 °C and intense

modification 210 °C. This gives you the opportunity to choose between lighter and darker materials to suit your desired color palette.

Thermally modified timber is suitable for interior and exterior use in both homes and public spaces.

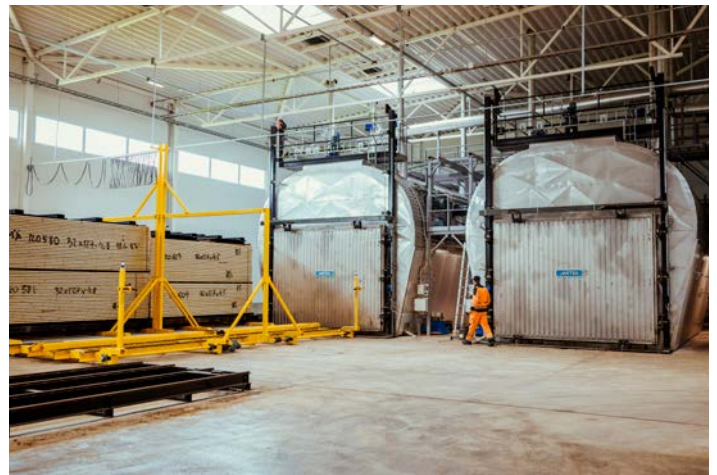

Thermal kilns at Loo production unit.

Our thermally modified wood for sauna design undergoes a process that uses a precise combination of heat and steam.

This process is completely natural.

THE HEAT

ENHANCES THE WOOD’S STRUCTURE THROUGHOUT

THE STEAM

GIVES US FULL CONTROL OVER THE PROCESS



THERMALLY MODIFIED WOOD
Naturally enhanced using only heat & steam



DIMENSIONAL STABILITY
Enhanced dimensional stability in changing weather conditions



CHEMICAL-FREE
Thermal modification process is entirely natural



DURABILITY
Improved durability and rot resistance



BETTER INSULATING QUALITIES
Reduced thermal conductivity



NON-HAZARDOUS WASTE
Safe waste handling

3. Wood treatments and finishes

As well as thermal modification, we also offer other treatments for your unique

wellness space with brushed, painted, and patterned finishes to choose from.

BRUSHING

Brushing emphasizes the natural texture of the wood, giving the panels an elegant look that's normally associated with aged wood. This attractive patterned surface can be further highlighted on cladding and interior walls with creative lighting design.

PAINTING

Thermory offers painted boards and panels, which are ideal for the sauna. The standard colors are white, gray, and black and you can also try other colors to engage your creative side – just ensure that they're suitable for use in the sauna.

EMBOSSING

Embossing is our novelty technique that gives a beautiful distinctive pattern to the wood.



NATURAL



BRUSHED



EMBOSSED (IGNITE BY THERMORY)



PAINTED



4. Wood types for the sauna

Every sauna design is different – some prioritize practical aspects that will deliver a superior bathing experience, while others focus more on decorative elements and visual appeal. Whatever features you

choose for your sauna, there are certain universal principles, like using woods that don't overheat or secrete resin for the benches and selecting interior materials that are resistant to heat and moisture.

EUROPEAN ASPEN

Aspen is a deciduous tree of the willow family, in the Malpighiales order. It grows across Europe and in most of Asia, as well as northern Africa. Aspen makes an ideal sauna material because it doesn't secrete resin, create splinters, or get too hot. Its characteristic light tone and smooth texture give it an attractive look and make it perfect for painting. We offer a number of interior sauna elements in both natural and thermally modified aspen.

NATURAL



MEDIUM THERMO

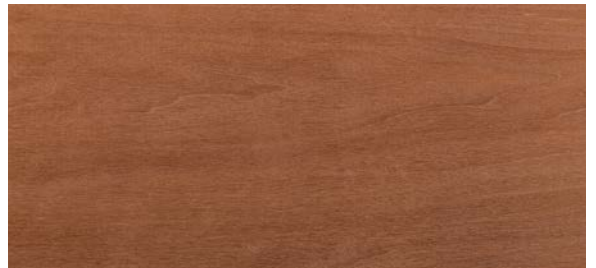

EUROPEAN BLACK ALDER

Alder, also known as black alder, is a perennial deciduous tree in the birch family of the Fagales order. It can be found in most of Europe, southwestern Asia, and northern Africa. Thanks to its reddish tone and pleasant texture, alder wood is popular as a finishing material in saunas. Alder is hardy and water-repellent, and it doesn't overheat. We use alder to produce a variety of interior sauna materials and products, with thermally modified and brushed finishes available

NATURAL



MEDIUM THERMO



INTENSE THERMO



RADIATA PINE

The radiata pine is a coniferous tree of the pine family, in the Pinales order. It can be seen growing in western North America, New Zealand, Australia, South Africa, Chile, and parts of Europe. Radiata pine's rapid growth and excellent quality make it among the most cultivated coniferous species. With no exposed knots, the wood doesn't secrete resin, splinter, or overheat, making it great for sauna benches. Wide boards, brushing to bring out the natural pattern, and the darker hue from thermal modification offer an additional touch of luxury.

INTENSE
THERMO



MAGNOLIA

Magnolia, also known as the tulip tree, belongs to the magnolia family in the Magnoliales order. It grows mainly in central and eastern parts of North America. Magnolia has a creamy, golden hue with darker areas, and a characteristic pattern with similarities to ash and radiata pine. Along with its low density, this makes it perfect for the sauna. Wide boards and the dark shade achieved by thermal modification offer a luxurious, exclusive finish.

MEDIUM
THERMO



WESTERN RED CEDAR

Western red cedar is an evergreen coniferous tree in the cypress family of the Pinales order that grows in the western part of North America. The western red cedar, also known as Pacific red cedar, is perfect for saunas because it doesn't secrete resin or overheat, and it is also water repellent. Red cedar is known for its pleasantly rich aroma and its exquisite reddish color with a range of natural shades.

NATURAL



NORDIC SPRUCE

Spruce, or European spruce, is an evergreen coniferous tree of the pine family in the Pinales order. It grows in northern, central, and eastern Europe. The wood of the Norway spruce is almost white, with a light yellowish undertone – it is one of the lightest coniferous woods. Spruce is often used as timber, and for saunas it is generally preferred for outer walls. We can also brush the wood to further enhance its attractive natural pattern.

NATURAL



MEDIUM
THERMO



5. Sauna materials

We have everything to create DIY sauna – a wide choice of wood species with various treatment options and a broad selection of profiles and panel sizes from

smart and narrow to luxuriously wide. All of this adds up to endless combinations to make sure that your sauna is uniquely designed for you.

5.1 WALL PANELS

PROFILE	WOOD	MODIFICATIONS	THICKNESS (MM)	WIDTH (MM)	COVERING WIDTH (MM)
	Aspen	-	12	65	55
			12	90	80
			15	68	58
			15	90	80
			15	125	115
	Alder	-	12	65	55
			12	90	80
			15	68	58
			15	90	80
			15	125	115
	Cedar	-	15	140	130
	Thermo-aspen	Medium	12	65	55
			12	90	80
			15	68	58
			15	90	80
Thermo-alder	Medium	15	125	115	
		15	68	58	
		15	90	80	
Thermo-alder	Intense	15	125	115	
		15	85	75	



All Thermory installation and maintenance guides can be found on our homepage www.thermory.com.

All pictures are for illustrative purposes only. Actual products may differ in appearance as wood is a natural material – each piece is unique, just like us.

PROFILE



STS4

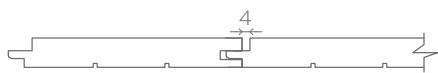

STS10



VIIVA



WOOD	MODIFICATIONS	THICKNESS (MM)	WIDTH (MM)	COVERING WIDTH (MM)
Aspen	-	12	90	80
		15	68	58
		15	90	80
		15	120	110
		15	140	130
		15	160	150
Alder	-	12	90	80
		15	68	58
		15	90	80
		15	120	110
		15	140	130
		15	160	150
Thermo-aspen	Medium	12	90	80
		15	68	58
		15	90	80
		15	120	110
		15	140	130
		15	160	150
		19	185	175
Thermo-alder	Medium	15	68	58
		15	90	80
		15	120	110
		15	140	130
		15	160	150
Thermo-radiata pine	Intense	15	90	80
		15	140	130
		19	185	175
Thermo-magnolia	Medium	15	145	137
		15	170	162
Aspen	-	15	68	58
Thermo-aspen	Medium	15	68	58

PROFILE

STS VALEURA

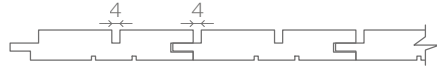

SRP



STEP

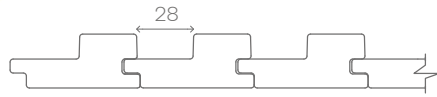

ROMBTO

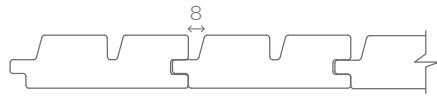

Kyte



Kyte-S

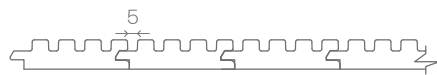

Vire by Siparila

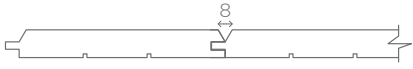

WOOD	MODIFICATIONS	THICKNESS (MM)	WIDTH (MM)	COVERING WIDTH (MM)
Aspen	-	15	68	58
		15	90	80
Alder	-	15	90	80
Thermo-aspen	Medium	15	68	58
		15	90	80
Thermo-alder	Medium	15	68	58
		15	90	80
Aspen	-	15	61	53
Alder	-	15	61	53
Thermo-aspen	Medium	15	61	53
Aspen	-	27	64	56
Alder	-	27	64	56
Thermo-aspen	Medium	27	64	56
Thermo-alder	Intense	27	64	56
Aspen	-	27	90	82
Alder	-	27	90	82
Thermo-aspen	Medium	27	90	82
Thermo-alder	Intense	27	90	82
Thermo-alder	Intense	26	85	82
Thermo-aspen	Medium	15	60	53
Thermo-aspen	Medium	15	60	53
Thermo-aspen	Medium	15	69	59

PROFILE	WOOD	MODIFICATIONS	THICKNESS (MM)	WIDTH (MM)	LENGTH (MM)	PANELS PER BOX
STF 			15	65	293	64
			15	65	578	32
	Aspen	-	15	65	1148	16
	Alder	-	15	85	293	64
	Thermo-aspen	Medium	15	85	578	32
	Thermo-alder	Intense	15	85	1148	16
			15	120	293	32
			15	120	578	16
			15	120	1148	8

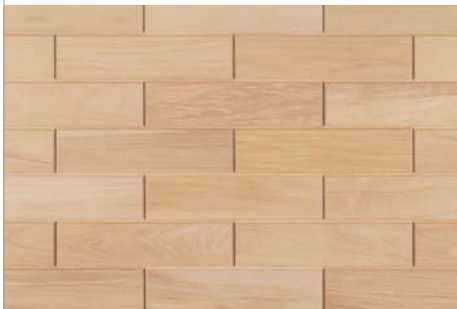
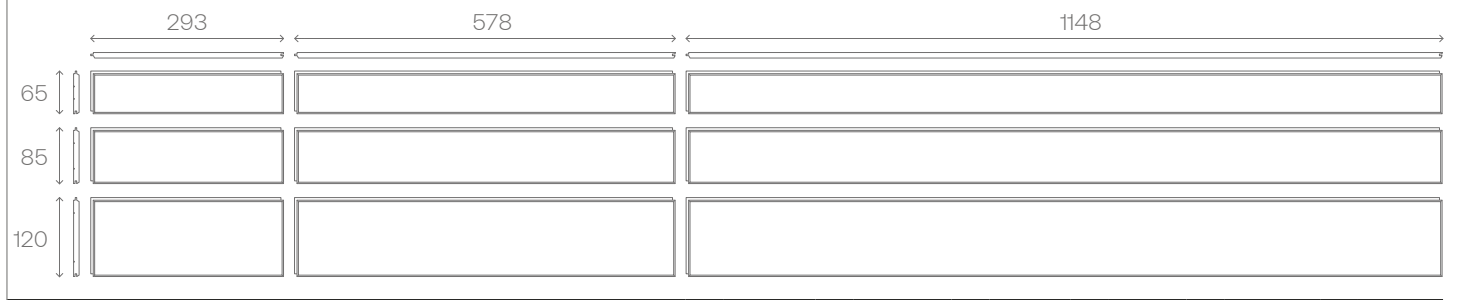

STF 15x85 aspen



STF 15x85 alder



STF 15x85 thermo-aspen



STF 15x85 thermo-alder intense

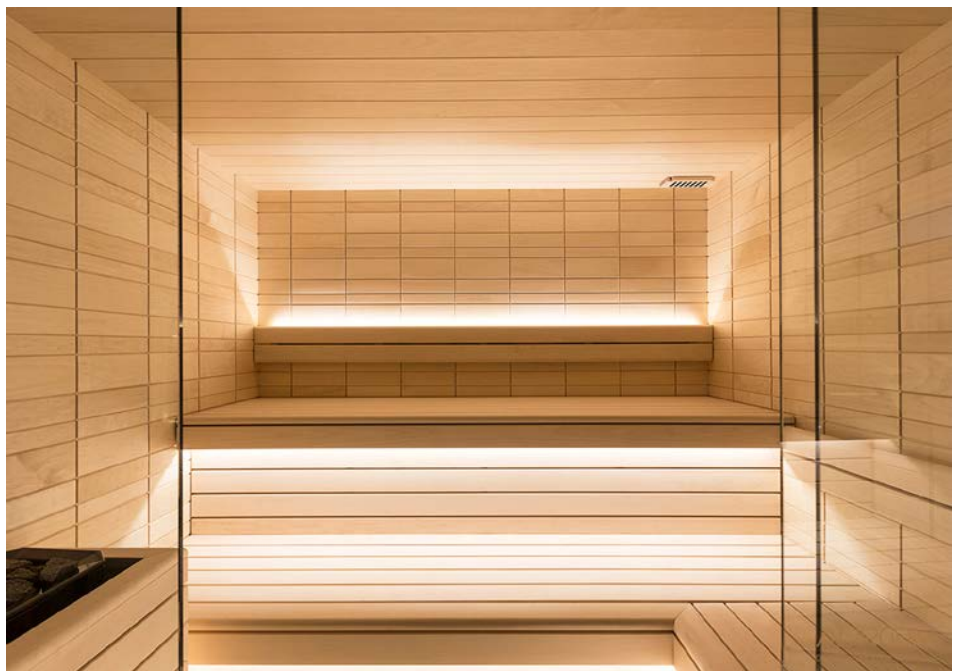



STF 293 x 65 / 85 / 120 aspen, Auroom Electa design sauna.



All Thermory installation and maintenance guides can be found on our homepage www.thermory.com.

All pictures are for illustrative purposes only. Actual products may differ in appearance as wood is a natural material – each piece is unique, just like us.

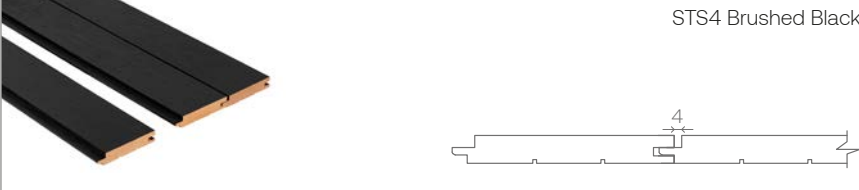
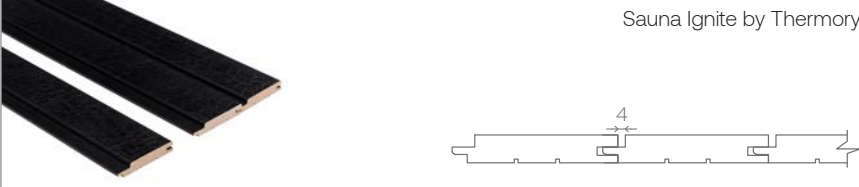
COATED WALL PANELS

PROFILE	WOOD	THICKNESS (MM)	WIDTH (MM)	COVERING WIDTH (MM)
 <p>SRP</p> <p>Black</p> <p>White</p>	Aspen	15	61	53
 <p>STS4</p> <p>Black</p> <p>White</p>	Alder	15	90	80
 <p>STS4 Brushed Black</p>	Alder	15	120	110
 <p>Sauna Ignite by Thermory</p>	Alder	15	90	80
	Alder	15	120	110

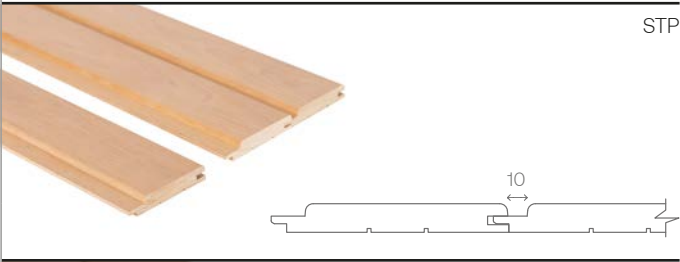
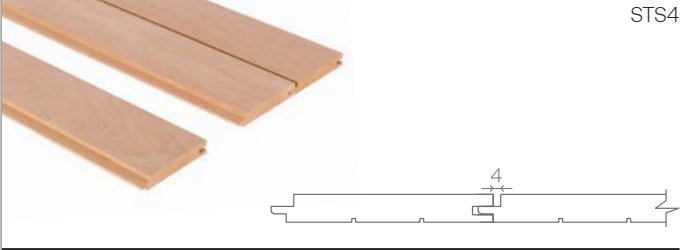
COUNTRY GRADE

PROFILE	WOOD	MODIFICATIONS	THICKNESS (MM)	WIDTH (MM)	COVERING WIDTH (MM)	GRADE
 <p>STP</p>	Alder	-	15	90	80	AB
			15	90	80	B
			15	125	115	B
	Spruce	-	15	90	80	AB
	Thermospruce	Medium	15	90	80	AB
 <p>STS4</p>	Alder	-	15	90	80	B
			15	120	110	B
	Thermoalder	Medium	15	90	80	B
			15	120	110	B
 <p>UNEDGED PANEL</p>	Alder	-	22	250	120-250	AB















All Thermory installation and maintenance guides can be found on our homepage www.thermory.com.







All pictures are for illustrative purposes only. Actual products may differ in appearance as wood is a natural material – each piece is unique, just like us.

5.2 MOULDINGS

Thermory's selection of sauna mouldings serves a variety of purposes – covering gaps, filling in corners, and rounding off

the visual theme. Whether you're after a traditionally decorative style or a standard look, Thermory has you covered.

PROFILE	WOOD	MODIFICATIONS	THICKNESS (MM)	WIDTH (MM)
 	UK	Aspen	12	42
	Alder	-		
	Thermo-aspen	Medium		
	Thermo radiata pine	Intense		
 	KA	Aspen	14	60
	Alder	-		
	Thermo-aspen	Medium		
	Thermo-alder	Intense		
 	SHP	Aspen	15	45
	Alder	-		
	Thermo-aspen	Medium		
 	SHP	Aspen	21	21
	Alder	-		
	Thermo-aspen	Medium		
	Thermo radiata pine	Intense		
   	VÄ	Aspen	21	42
	Alder	-	28	28
	Thermo-aspen	-	28	42
	Thermo radiata pine	-	21	42
	Alder	-	28	28
	Thermo-aspen	Medium	28	42
	Thermo radiata pine	Intense	21	42
	Aspen	-	15	18
	Alder	-	15	18
	Thermo-aspen	Medium	15	18
	Thermo radiata pine	Intense	15	18
	 	SI	Aspen	14
Alder		-		
Thermo-aspen		Medium		
Thermo-alder		Intense		
Thermo radiata pine		Intense		

PROFILE	WOOD	MODIFICATIONS	THICKNESS (MM)	WIDTH (MM)
 <p>SI</p> 	Aspen	-	25	25
	Alder			
	Thermo-aspen			
 <p>Cover mouldings KA</p> 	Aspen	-	8	34
			8	65
	Alder		8	34
			8	65
	Thermo-aspen		8	34
			8	65
 <p>Cover mouldings T</p> 	Aspen	-	17	32
	Alder			
	Thermo-aspen			
	Thermo-alder			



Walls: STP 15x90 alder, benches: SHP 28x90 alder. Spa sauna in Germany.

All Thermory installation and maintenance guides can be found on our homepage www.thermory.com.

All pictures are for illustrative purposes only. Actual products may differ in appearance as wood is a natural material – each piece is unique, just like us.

5.3 BENCH BOARDS

PROFILE	WOOD	MODIFICATIONS	THICKNESS (MM)	WIDTH (MM)
	Aspen		21	65
			21	90
			28	42
			28	65
			28	90
			28	120
			28	140
			28	160
	Alder	-	21	90
			28	42
			28	65
			28	90
			28	120
			28	140
	Cedar		26	90
			26	140
	Thermo-aspen	Medium	21	65
			21	90
			28	42
			28	65
			28	90
			28	120
			28	140
			28	160
	Thermo-alder		21	90
			28	90
			28	120
	Thermo-alder	Intense	28	140
27			42	
27			85	
Thermo-alder		27	115	
		27	135	
		27	135	
Thermo radiata pine	Intense	26	92	
		26	140	
		26	185	
Thermo-magnolia	Medium	28	185	







All Thermory installation and maintenance guides can be found on our homepage www.thermory.com.

All pictures are for illustrative purposes only. Actual products may differ in appearance as wood is a natural material – each piece is unique, just like us.

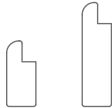

COATED BENCH BOARDS

PROFILE	WOOD	THICKNESS (MM)	WIDTH (MM)
  	Aspen	28	120

5.4 BENCH FRONTBOARDS

PROFILE	WOOD	MODIFICATIONS	THICKNESS (MM)	WIDTH (MM)
 	Aspen	-	80	108
 	Aspen	-	40	90
	Alder	-	40	90
 	Aspen	-	40	140
	Thermo-aspen	Medium	40	90
 	Aspen	-	40	140
	Alder	-	68	68
	Thermo-aspen	Medium	68	68
	Thermo-aspen	Medium	86	86

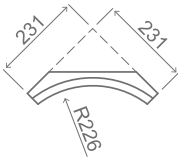
BENCH CORNER PIECES

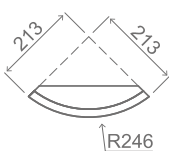
PROFILE	WOOD	MODIFICATIONS	THICKNESS (MM)	WIDTH (MM)
 	Aspen	-	40	140
	Alder	-		
	Thermo-aspen	Medium		
 	Aspen	-	40	140
	Alder	-		
	Thermo-aspen	Medium		

All Thermory installation and maintenance guides can be found on our homepage www.thermory.com.



All pictures are for illustrative purposes only. Actual products may differ in appearance as wood is a natural material – each piece is unique, just like us.

6. Ready-made sauna elements

Create perfect wellness and relaxation space with our ready-to-use sauna elements. With bench sets, floor grids,

and heater guards as well as doors and other accessories.

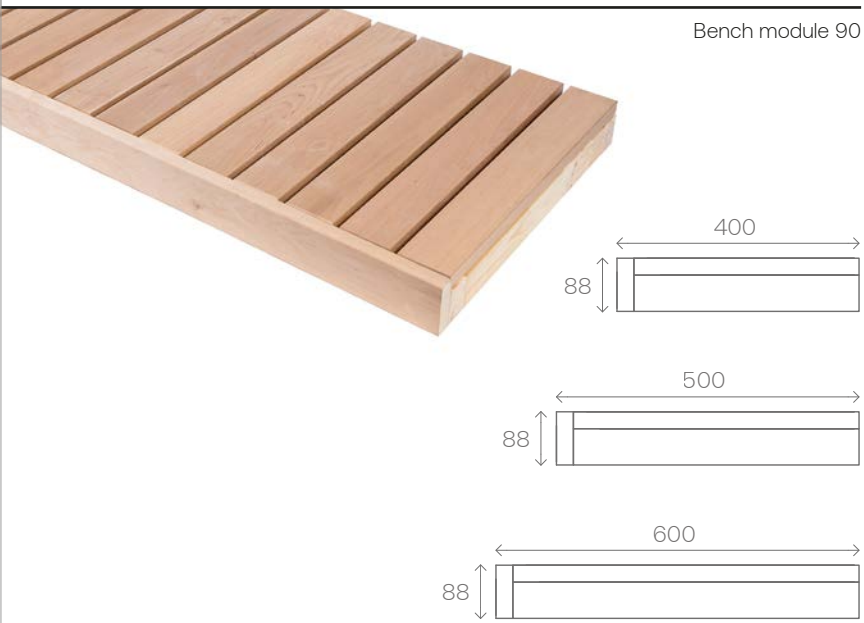
6.1 BENCH MODULES

PRODUCT	WOOD	WIDTH (MM)	LENGTH (MM)
<p data-bbox="767 725 943 752">Bench module 90</p>  	Aspen	600	1800
		600	2100
		500	2100
		400	1800
		400	2100
	Alder	600	1600
		600	1800
		600	2100
		500	2100
		400	1600
		400	1800
		400	2100
	Thermo-aspen (M)	600	1800
		600	2100
500		2100	
400		1800	
400		2100	
<p data-bbox="767 1650 943 1677">Corner module 90</p> 	Aspen	600	600
		500	500
		400	400
	Alder	600	600
		500	500
		400	400
	Thermo-aspen (M)	600	600
		500	500
		400	400

All pictures are for illustrative purposes only. Actual products may differ in appearance as wood is a natural material – each piece is unique, just like us.

PRODUCT



Bench module 140

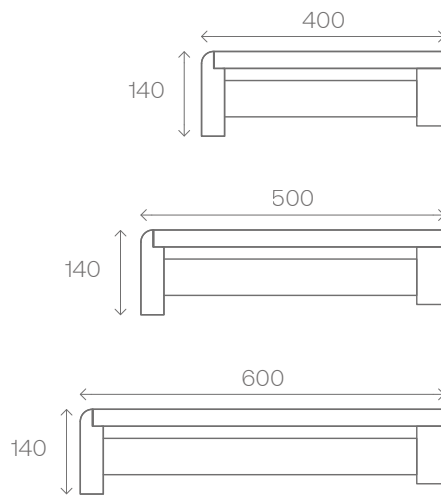

Corner module 140

WOOD

WIDTH (MM)

LENGTH (MM)

Aspen	600	1600
	600	1800
	600	2100
	600	2400
	500	1600
	500	2100
	400	1600
	400	1800
	400	2100
	400	2400
Alder	600	1600
	600	1800
	600	2100
	600	2400
	500	1600
	500	2100
	400	1600
	400	1800
	400	2100
	400	2400
Thermo-aspen (M)	600	1600
	600	1800
	600	2100
	600	2400
	500	1600
	500	2100
	400	1600
	400	1800
	400	2100
	400	2400
Aspen	600	600
	500	500
	400	400
Alder	600	600
	500	500
	400	400
Thermo-aspen (M)	600	600
	500	500
	400	400

PRODUCT

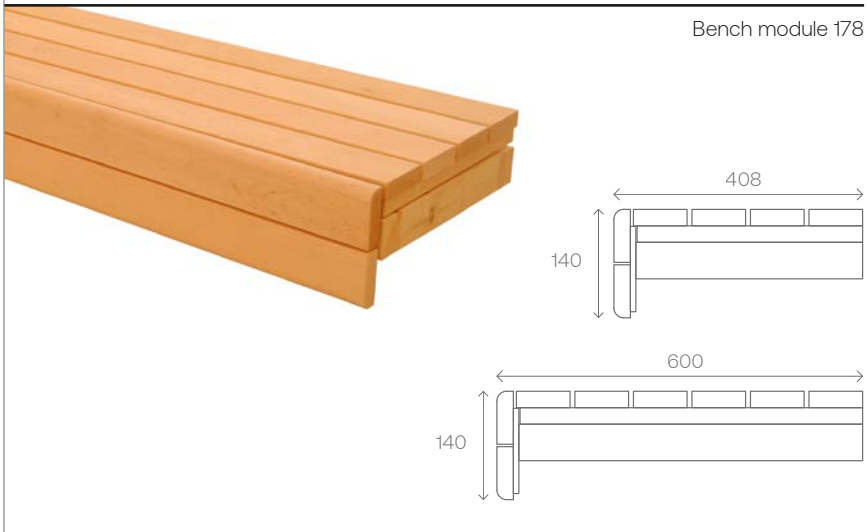

WOOD	WIDTH (MM)	LENGTH (MM)
Aspen	200	600 R
	200	600 L
	200	400 R
	200	400 L
Alder	200	600 R
	200	600 L
	200	400 R
	200	400 L
Thermo-aspen (M)	200	600 R
	200	600 L
	200	400 R
	200	400 L
Alder	600	2350
	408	2350

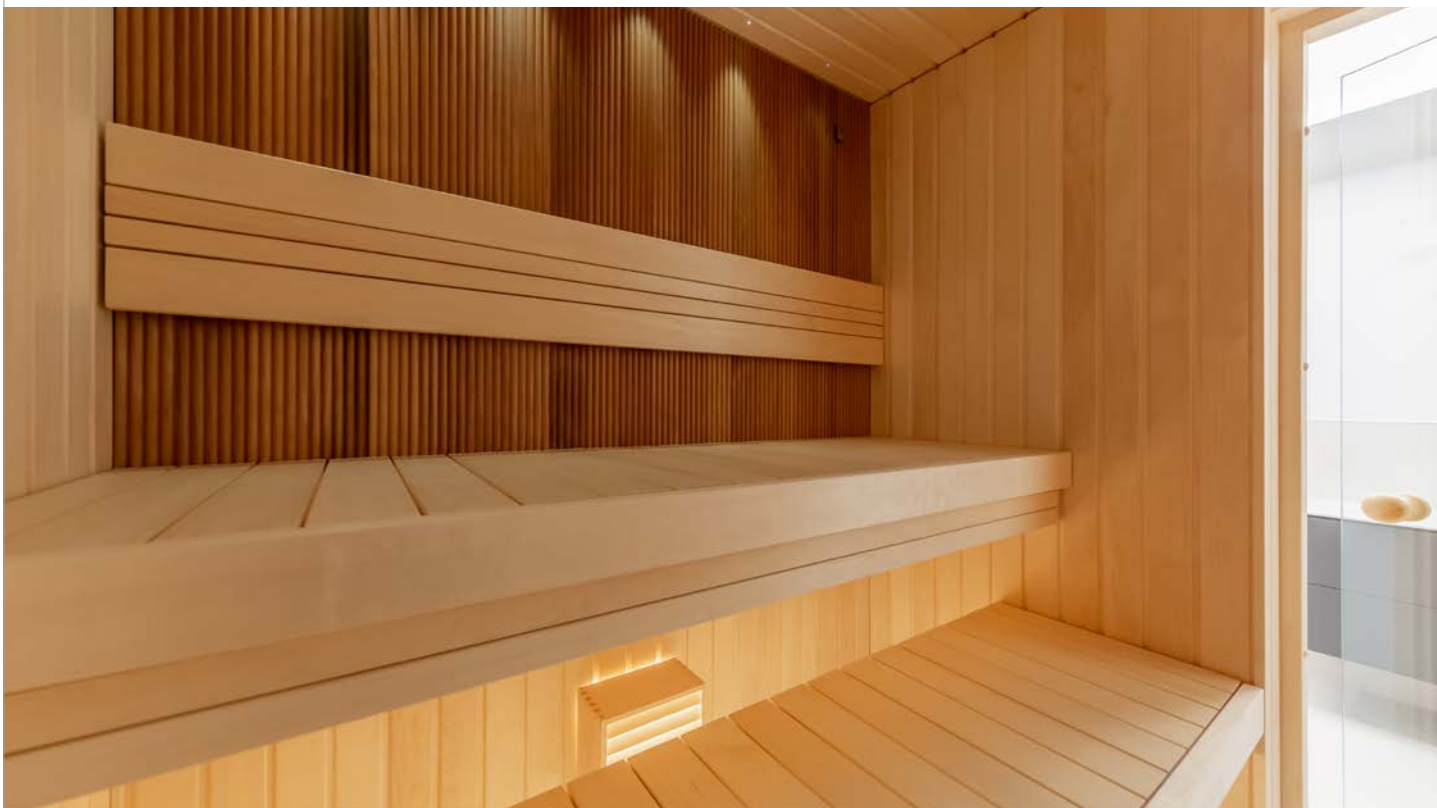











SRP thermo-aspen and STP aspen walls. Private house in Estonia. Photo by Elvo Jakobson

All Thermory installation and maintenance guides can be found on our homepage www.thermory.com.

All pictures are for illustrative purposes only. Actual products may differ in appearance as wood is a natural material – each piece is unique, just like us.











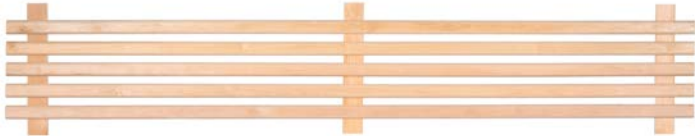

6.2 BACKRESTS

PRODUCT	WOOD	THICKNESS (MM)	HEIGHT (MM)	LENGTH (MM)
 	Alder	28	200	2050
	Thermo-aspen	28	200	2050
 	Aspen	28	300	1550
		28	300	1750
		28	300	2050
	Alder	28	300	1550
		28	300	1750
		28	300	2050
		28	300	1550
	Thermo-aspen (M)	28	300	1750
		28	300	2050
		28	300	2050
 	Aspen	16	300	1550
		16	300	1750
		16	300	2050
		16	300	2350
	Alder	16	300	1550
		16	300	1750
		16	300	2050
		16	300	2350
	Thermo-aspen (M)	16	300	1550
		16	300	1750
		16	300	2050
		16	300	2050
		16	300	2050
		16	300	2350
 	Aspen	28	310	2050
	Alder	28	310	2050
	Thermo-aspen (M)	28	310	2050
 	Alder	28	237	2050
<p>Corner backrest</p>  	Aspen	28	400	850
	Alder			
	Thermo-aspen (M)			

All Thermory installation and maintenance guides can be found on our homepage www.thermory.com.

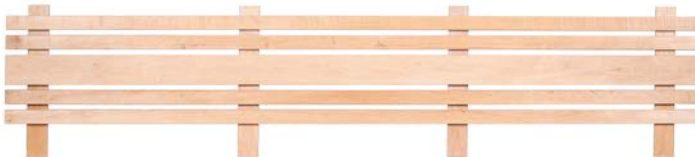
All pictures are for illustrative purposes only. Actual products may differ in appearance as wood is a natural material – each piece is unique, just like us.







6.3 BENCH SKIRTS

PRODUCT	WOOD	THICKNESS (MM)	HEIGHT (MM)	LENGTH (MM)		
 	Aspen	14	300	1600		
		14	300	1800		
		14	300	2100		
		14	300	2400		
	Alder	14	300	1600		
		14	300	1800		
		14	300	2100		
		14	300	2400		
	Thermo-aspen (M)	14	300	1600		
		14	300	2100		
 	Aspen	15	300	1600		
		15	300	1800		
		15	300	2100		
		15	300	2400		
	Alder	15	300	1600		
		15	300	1800		
	Thermo-aspen (M)	15	300	1600		
		15	300	1800		
		15	300	2100		
		15	300	2400		
 	Alder	16	300	1800		
		16	300	2100		
	Thermo-aspen (M)	16	300	1800		
		16	300	2100		
		 	Alder	16	350	2100
				16	350	2100
Thermo-aspen (M)	16		350	2100		
	16		350	2100		
 	Thermo-aspen (M)	28	320	2050		
		28	320	2350		
	 	Alder	21	300	2100	
						Thermo-aspen (M)

All Thermory installation and maintenance guides can be found on our homepage www.thermory.com.

All pictures are for illustrative purposes only. Actual products may differ in appearance as wood is a natural material – each piece is unique, just like us.

6.4 MOVABLE BENCHES



PRODUCT	WOOD	MODIFICATIONS	WIDTH (MM)	LENGTH (MM)	HEIGHT (MM)
	Alder	-	28 / 300	600	338
	Alder	-	28/380	580	350
	Thermo-aspen	Medium			
	Alder	-	90 / 360	1500	350
	Thermo-aspen	Medium			
	Thermo-aspen	Medium	134 / 400	657	300
	Alder	-	108 / 460	700	460
	Thermo-aspen	Medium			
	Thermo-aspen	Medium	108 / 460	1500	460

All Thermory installation and maintenance guides can be found on our homepage www.thermory.com.

All pictures are for illustrative purposes only. Actual products may differ in appearance as wood is a natural material – each piece is unique, just like us.

PRODUCT	WOOD	MODIFICATIONS	WIDTH (MM)	LENGTH (MM)	HEIGHT (MM)
	Aspen	-	140 / 400	700	350
	Alder	-			
	Thermo-aspen	Medium			
	Thermo-aspen	Medium	140 / 400	1500	350
	Alder	-	140 / 700	700	500
	Thermo-aspen	Medium	140 / 700	700	500
	Thermo-aspen	Medium	90/400	670	404

6.5 HEATER GUARDS

PRODUCT	WOOD	MODIFICATIONS	WIDTH (MM)	LENGTH (MM)	HEIGHT (MM)
	Aspen	-	90 / 400	600	446
	Alder				
	Thermo-aspen				
	Aspen	-	90 / 800	800	445
	Alder				
	Thermo-aspen				

6.6 ARM RESTS

PRODUCT	WOOD	MODIFICATIONS	WIDTH (MM)	LENGTH (MM)	HEIGHT (MM)
	Aspen	-	20	600	1300
	Alder		20	600	1300
	Thermo-aspen	Medium	20	600	1300

6.7 FLOOR GRIDS



PRODUCT	WOOD	MODIFICATIONS	THICKNESS (MM)	WIDTH (MM)	LENGTH (MM)	
	Aspen	-	12	600	1000	
			14	600	1200	
			14	800	900	
	Alder		12	600	1000	
			14	600	1200	
			14	800	900	
	Thermo-aspen		12	Medium	600	1000
			14	600	1200	
			14	800	900	
	Thermo-spruce	Medium	15	600	10 000	
			15	800	10 000	

All Thermory installation and maintenance guides can be found on our homepage www.thermory.com.

All pictures are for illustrative purposes only. Actual products may differ in appearance as wood is a natural material – each piece is unique, just like us.

7. Sauna accessories

7.1 LIGHTNING COVERS

PRODUCT	WOOD	MODIFICATIONS	THICKNESS (MM)	WIDTH (MM)	HEIGHT (MM)
	Aspen	-	100	250	270
	Alder				
	Aspen	-	100	300	300 C
	Alder				
	Thermo-aspen				
	Alder	-	140	240	400 C
	Thermo-aspen				

7.2 VENTILATION HATCHES

PRODUCT	WOOD	MODIFICATIONS	WIDTH (MM)	LENGTH (MM)
	Aspen	-	144	282
	Alder			
	Thermo-aspen			

All Thermory installation and maintenance guides can be found on our homepage www.thermory.com.

All pictures are for illustrative purposes only. Actual products may differ in appearance as wood is a natural material – each piece is unique, just like us.

7.3 VENTILATION GRIDS

PRODUCT	WOOD	MODIFICATIONS	WIDTH (MM)	LENGTH (MM)
	Aspen	-	145	225
	Alder			
	Thermo-aspen	Medium	150	190

7.4 HEAD RESTS

PRODUCT	WOOD	THICKNESS (MM)	WIDTH (MM)	LENGTH (MM)
	Aspen	97	280	335
		145	335	335
	Alder	97	280	335
		145	335	335

7.5 SEAT RESTS

PRODUCT	WOOD	THICKNESS (MM)	WIDTH (MM)	LENGTH (MM)
	Alder	10	310	385

All Thermory installation and maintenance guides can be found on our homepage www.thermory.com.

All pictures are for illustrative purposes only. Actual products may differ in appearance as wood is a natural material – each piece is unique, just like us.

8. Sauna doors

Thermory's range of sauna doors includes several designs in both wood and glass. All of our doors come with a selection of high-quality handles, hinges, and locks to ensure that you can find the right doors for your sauna.



TRENDLINE



DOOR DIMENSIONS

DIMENSIONS	FRAME	GLASS	HINGES / PCS
6 x 19	590 x 1890	520 x 1854	Abloy / 2
6 x 20	590 x 1990	520 x 1954	Abloy / 2
6 x 21	590 x 2090	520 x 2054	Abloy / 2
7 x 19	690 x 1890	620 x 1854	Abloy / 2
7 x 20	690 x 1990	620 x 1954	Abloy / 2
7 x 21	690 x 2090	620 x 2054	Abloy / 2
8 x 19	790 x 1890	720 x 1854	Abloy / 2
8 x 20	790 x 1990	720 x 1954	Abloy / 3
8 x 21	790 x 2090	720 x 2054	Abloy / 3

HINGES
Abloy bronze



LOCK
Roller lock



HANDLE
Trendline



FRAME 42 x 92



Pine



Aspen



Alder

GLASS 8 MM TEMPERED

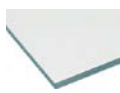

Clear

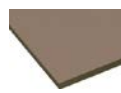

Bronze

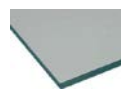

Gray

Trendline with magnetic lock

CLASSIC



DOOR DIMENSIONS

DIMENSIONS	FRAME	GLASS	HINGES / PCS
6 x 19	590 x 1890	520 x 1854	Abloy / 2
6 x 20	590 x 1990	520 x 1954	Abloy / 2
6 x 21	590 x 2090	520 x 2054	Abloy / 2
7 x 19	690 x 1890	620 x 1854	Abloy / 2
7 x 20	690 x 1990	620 x 1954	Abloy / 2
7 x 21	690 x 2090	620 x 2054	Abloy / 2
8 x 19	790 x 1890	720 x 1854	Abloy / 2
8 x 20	790 x 1990	720 x 1954	Abloy / 3
8 x 21	790 x 2090	720 x 2054	Abloy / 3

HINGES

Abloy bronze



LOCK

Roller lock



HANDLE

Classic



Classic with magnetic lock

FRAME 42 x 92



Pine



Aspen



Alder

GLASS 8 MM TEMPERED

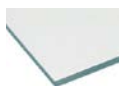

Clear

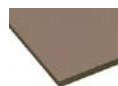

Bronze

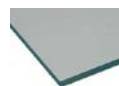

Gray

PREMIUM



DOOR DIMENSIONS

DIMENSIONS	FRAME	GLASS	HINGES / PCS
6 x 19	590 x 1890	520 x 1854	Abloy / 2
6 x 20	590 x 1990	520 x 1954	Abloy / 2
6 x 21	590 x 2090	520 x 2054	Abloy / 2
7 x 19	690 x 1890	620 x 1854	Abloy / 2
7 x 20	690 x 1990	620 x 1954	Abloy / 2
7 x 21	690 x 2090	620 x 2054	Abloy / 2
8 x 19	790 x 1890	720 x 1854	Abloy / 2
8 x 20	790 x 1990	720 x 1954	Abloy / 3
8 x 21	790 x 2090	720 x 2054	Abloy / 3

LOCK

Roller lock



HANDLE

Premium



HINGES

Abloy bronze



Abloy Silver



RV stainless steel



FRAME 42 x 92



Pine



Aspen



Alder



Black painted deciduous wood

GLASS 8 MM TEMPERED

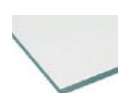

Clear

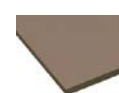

Bronze

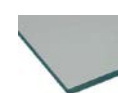

Gray

EXCLUSIVE



DOOR DIMENSIONS

DIMENSIONS	FRAME	GLASS	HINGES / PCS
6 x 19	590 x 1890	520 x 1854	Abloy / 2
6 x 20	590 x 1990	520 x 1954	Abloy / 2
6 x 21	590 x 2090	520 x 2054	Abloy / 2
7 x 19	690 x 1890	620 x 1854	Abloy / 2
7 x 20	690 x 1990	620 x 1954	Abloy / 2
7 x 21	690 x 2090	620 x 2054	Abloy / 2
8 x 19	790 x 1890	720 x 1854	Abloy / 2
8 x 20	790 x 1990	720 x 1954	Abloy / 3
8 x 21	790 x 2090	720 x 2054	Abloy / 3

HINGES

Abloy bronze



LOCK

Roller lock



HANDLE

Exclusive

FRAME 42 x 92



GLASS 8 MM TEMPERED



SAILOR



DOOR DIMENSIONS

DIMENSIONS	FRAME
7 x 19	690 x 1880
7 x 20	690 x 1980
7 x 21	690 x 2080
8 x 19	790 x 1880
8 x 20	790 x 1980
8 x 21	790 x 2080
9 x 19	890 x 1880
9 x 20	890 x 1980
9 x 21	890 x 2080

LOCK

Roller lock



HANDLE

Trendline



FRAME 42 x 92 / DOOR PANELING STP 15x90

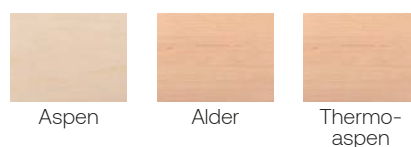

GLASS 8 MM TEMPERED



NOTE: This door is unsuitable for rooms that can become humid.

All pictures are for illustrative purposes only. Actual products may differ in appearance as wood is a natural material – each piece is unique, just like us.

FOREST



DOOR DIMENSIONS

DIMENSIONS	FRAME
7 x 19	690 x 1890

LOCK

Roller lock



FRAME 42 x 92 / DOOR PANELING STP 15x90



Spruce

GLASS 8 MM TEMPERED

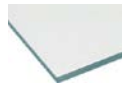

Clear

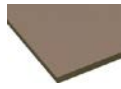

Bronze

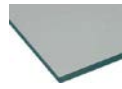

Gray

NOTE: This door is unsuitable for rooms that can become humid.

STEAM SAUNA



DOOR DIMENSIONS

DIMENSIONS	FRAME	GLASS	HINGES / PCS
7 x 19	690 x 1890	620 x 1854	Abloy / 2
7 x 20	690 x 1990	620 x 1954	Abloy / 2
7 x 21	690 x 2090	620 x 2054	Abloy / 2
8 x 19	790 x 1890	720 x 1854	Abloy / 2
8 x 20	790 x 1990	720 x 1954	Abloy / 3
8 x 21	790 x 2090	720 x 2054	Abloy / 3
9 x 19	890 x 1890	820 x 1854	Abloy / 2
9 x 20	890 x 1990	820 x 1954	Abloy / 3
9 x 21	890 x 2090	820 x 2054	Abloy / 3

HINGES

Abloy Silver



LOCK

Roller lock



HANDLE

Trendline metal



Premium metal-metal

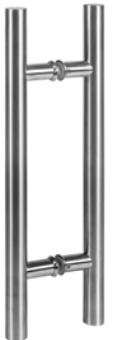

FRAME 42 x 70



Aluminium

GLASS 8 MM TEMPERED

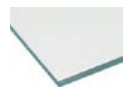

Clear

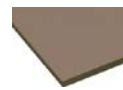

Bronze

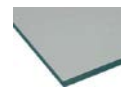

Gray

○ All Thermory doors come right-handed as standard but can be altered during installation.

○ It's also possible to customize your doors with matt glass, special-order handles, specific measurements,

and other tailored features – please contact our sales department to find out more about our prices and terms.

All Thermory installation and maintenance guides can be found on our homepage www.thermory.com.

All pictures are for illustrative purposes only. Actual products may differ in appearance as wood is a natural material – each piece is unique, just like us.

Thermo-aspen sauna, private house in Estonia. Photo by Elvo Jakobson

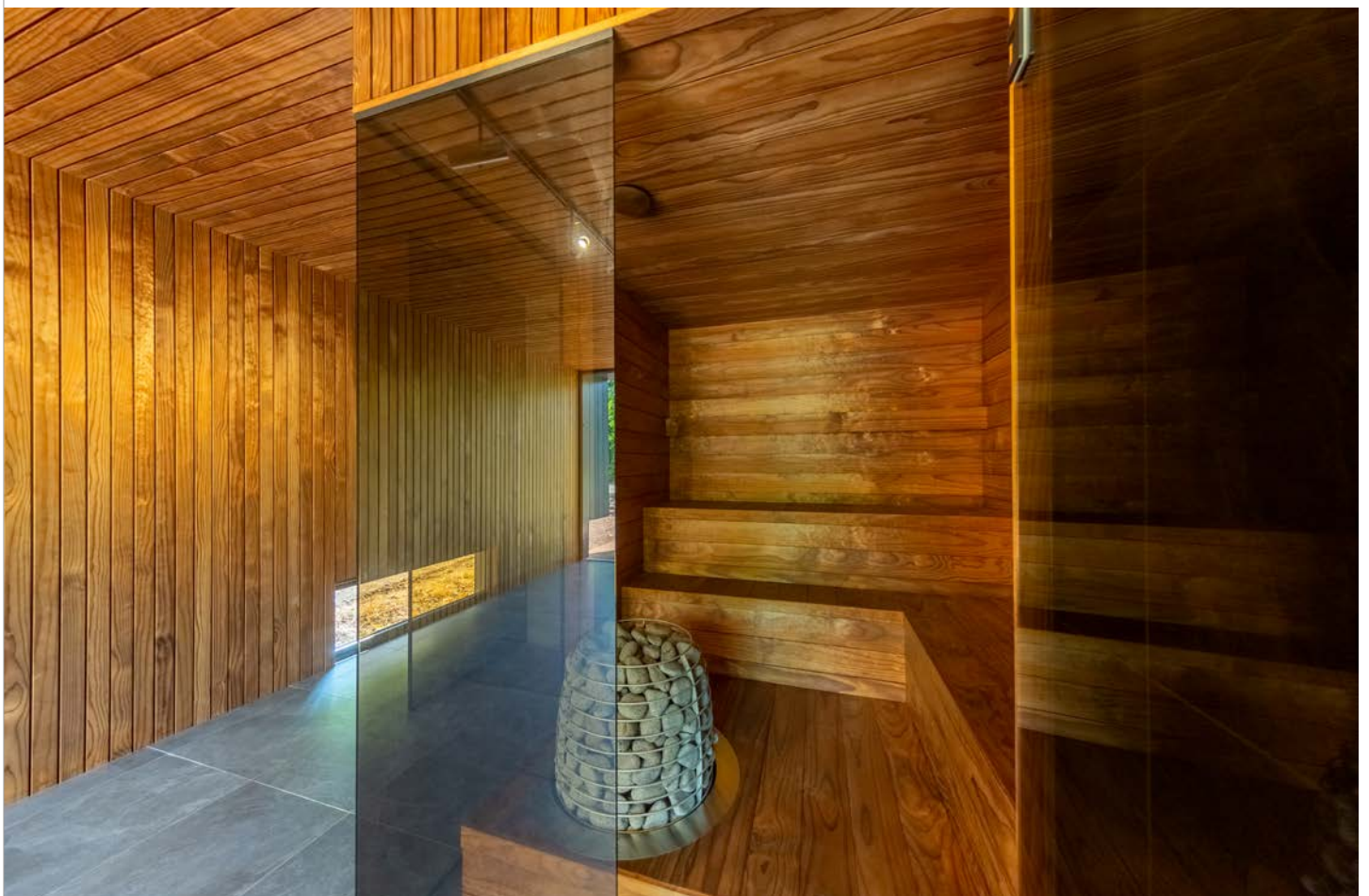

Thermo radiata pine sauna, private house, Estonia. Photo by Elvo Jakobson



Leave a lasting impact

THERMORY is a world leader in the thermal modification of wood. We offer high-quality, long-lasting solutions that benefit from environmentally friendly technology. We have spent the past two decades developing our expertise through close collaboration with architects, designers, builders and homeowners – constantly revising our product selection and refining our technology in the process.

THERMORY promotes a transparent and responsible corporate culture. We care about the environment and treat nature with deep respect. Our purchasing process is environmentally responsible, and we exercise high standards for quality and sustainability. Our timber is carefully inspected and harvested from sustainably

- DECKING
- CLADDING
- INTERIOR
- SAUNA

managed forests. If desired, we can offer PEFC, FSC or Nordic Swan Ecolabel-certified wood.



As a renewable resource that is both durable and an excellent insulator, wood is one of the most environmentally friendly choices for your construction projects. If you think it's important to protect our valuable resources long into the future, then we're on the same mission. We create lasting value, because we want to leave behind a more harmonious and sustainable world.

REAL WOOD PRODUCTS WITH BEAUTY AND STABILITY IN EVERY FIBER

